

CARVER

M-4.0t, TFM-4.0, TFM-42, TFM-45 MAGNETIC FIELD POWER AMPLIFIERS SERVICE MANUAL

CONTENTS	Page
1. SAFETY INFORMATION.....	3
2. INTRODUCTION.....	4
3. SPECIFICATIONS	5
4. CIRCUIT DESCRIPTIONS	6
5. TEST PROCEDURES	11
6. TROUBLESHOOTING GUIDE	17
7. BLOCK DIAGRAM.....	22
8. SCHEMATICS AND LAYOUTS.....	23
9. APPENDICES	
A. Parts Ordering.....	50
B. Parts Lists	51
C. Design History.....	74
D. Voltage Conversion	78
E. Service Bulletins	79

CARVER Corporation

SHIP TO:

20121 48th Ave. West
Lynnwood Wa. 98036
(206) 775-6245

MAIL TO:

P.O. Box 1237
Lynnwood Wa. 98046-1237

Published by:

CARVER Corporation
20121 48th Avenue West
Lynnwood, WA 98036
(206) 775-6245

©1991 by CARVER Corporation
All Rights reserved.
Printed in the U.S.A.

No part of this publication may be reproduced, stored in a data base or retrieval system, or transmitted in any form by any means electronic, mechanical, photocopying, recording or otherwise, without the prior written permission of the CARVER Corporation.

SECTION 1

SAFETY INFORMATION

WARNING.

Any person performing the procedures described in this manual will be exposed to hazardous voltages and the risk of electric shock.

Carver Corporation assumes that any person who removes the cover from the unit has been properly trained in protecting against avoidable injury and shock.

Therefore, the procedures described here are to be performed by qualified electronics service personnel only.

We recommend that the unit be tested only when line isolation is provided by an isolation transformer. The line cord of the unit must be disconnected and the power supply fully discharged before any components are replaced. Failure to do so may result in severe damage to the unit and the risk of electric shock.

The safety tests described below must be performed properly.



CAUTION:

Before returning the unit to the customer, one of the following safety tests must be performed.

1. Check the leakage current. Disconnect all signal path inputs and outputs. Connect the unit to 120 VAC supply and turn the power switch "ON". Using an ammeter, measure the current between each side of the linecord and chassis ground of the unit under test. If leakage current exceeds 0.5mA, the unit is defective.
2. Measure the resistance from either side of the linecord to chassis ground. If it is less than 500k ohms, the unit is defective.

WARNING - DO NOT return the unit to the customer if it fails one of these tests until the problem is located and corrected.

CAUTION

	CAUTION RISK OF ELECTRIC SHOCK DO NOT OPEN	
CAUTION: TO REDUCE THE RISK OF ELECTRIC SHOCK DO NOT REMOVE COVER (OR BACK) NO USER-SERVICEABLE PARTS INSIDE REFER SERVICING TO QUALIFIED PERSONNEL		



The lightning flash with arrowhead symbol within an equilateral triangle is intended to alert the user to the presence of uninsulated "dangerous voltage" within the product's enclosure, that may be of sufficient magnitude to constitute a risk of electric shock to persons.



The exclamation point within an equilateral triangle is intended to alert the user of the presence of important operating and maintenance (servicing) instructions in the literature accompanying the appliance.

SECTION 2 INTRODUCTION

This manual is intended for use by qualified, authorized personnel only.

Due to the unique and complex circuit designs of Carver Corporation, the following procedure is recommended to diagnose & repair problems with speed and accuracy.

The best way to figure out what is wrong is to learn what is working properly first. Then, through the process of elimination, the defective area can be located. Upon locating the defective area, you then would use your own preferred troubleshooting skills.

The removal of parts for testing, should be kept to an absolute minimum. "In circuit" analysis should provide you with enough data to determine correct operation.

Refer to the design history section of the service manual if you locate a part in the circuit that is not the same as the schematic. This section will be of great assistance to you in performing a correct repair.

At Carver Corporation we continually strive for the most reliable, cost-efficient product available.

When updates and service bulletins are sent to you, please take the time to review them and insert them into the correct service manuals.

The M-4.0t Magnetic Field Power Amplifier was released in April of 1988. The front panel was originally the Anodized Gray color that was characteristic of the Carver product line throughout the 1980's.

In July of 1989, the color of the front panel changed to Charcoal Black, which is now characteristic of the Carver product line in the 1990's.

In September of 1989 a limited number of TFM-4.0 amplifiers were produced as a transition to our TFM line of power amplifiers. The TFM-4.0 is the same as the M-4.0t except for the screening on the front panel.

In October of 1989, the TFM-42 and TFM-45 amplifiers were released. The basic amplifier design is the same as the M-4.0t; however, many cosmetic and auxiliary circuit changes were made to accommodate the new style front panels. Therefore, you will find separate schematics, board layout drawings and parts lists for the M-4.0t/TFM-4.0 and the TFM-42/45 amplifiers in this service manual. Please be sure you are referring to the drawings and parts lists that correspond to the model being serviced.

SECTION 3

SPECIFICATIONS

Specifications for the M-4.0t, TFM-4.0, TFM-42, TFM-45

Power Output:	
Continuous Average Output Power, Both channels driven:	375 watts per channel into 8Ω from 20 Hz to 20 kHz 500 watts per channel into 4Ω from 20 Hz to 20 kHz
Bridged-mono operation:	1000 watts per channel into 8Ω from 20Hz to 20 kHz
Power at Clipping, Both channels driven:	450 watts per channel into 8Ω at 1 kHz
Dynamic Headroom:	1.5dB @ 8 ohms 1.75dB @ 4 ohms
Frequency Response:	20Hz to 20kHz +/- 0.5dB
T.H.D.:	Less than 0.5%
IM Distortion:	Less than 0.15%
Noise:	-110 dB A-weighted, referenced to rated power -84.3dB A-weighted, referenced to 1 watt.
Input Impedance:	115kΩ 47kΩ after TFM-42 S/N 91110900001 TFM-45 S/N 91110400001
Sensitivity:	1.7V rms for rated power into 8 ohms
Damping Factor:	Greater than 7
Crosstalk:	Better than -45dB, 20-20kHz
Gain:	29.5dB (M-4.0t/TFM-4.0) 29.0dB (TFM-42/45)

Display:

Model	M-4.0t	TFM-4.0	TFM-42	TFM-45
Independent Clipping Indicators	X	X	X	
Protection LED Indicators	X	X		
Power Level LED Indicators	X	X	X	
Analog Meters				X

Size (H x W x D):	M-4.0t/TFM-4.0 TFM-42/45	3.5" x 19" x 10.5" (12.5" overall, including handles) 4.5" x 19" x 12.0" (14.25" overall, including handles)
Weight:	M-4.0t/TFM-4.0 TFM-42/45	23 lbs 25 lbs

Test Note: Accurate measurement depends on a sufficiently "stiff" AC supply. The 60 Hz AC line distortion must be below IHF specifications.

SECTION 4

CIRCUIT DESCRIPTION M-4.0t, TFM-4.0, TFM-42, TFM-45

TECHNICAL DESCRIPTION

The unconventional design of this amplifier is described in the following circuit description. Read this information carefully before attempting to repair this unit.

This circuit description is based on the TFM-45 amplifier. Any part of the circuit that is unique to the M-4.0t, TFM-4.0, TFM-42 or TFM-45 will be identified as such.

The M-4.0t, TFM-4.0, TFM-42/45 amplifiers consist of four types of circuit boards:

- * Amplifier
- * Primary Circuit and Regulator
- * Display
- * Main Power Supply, Protection and Input Circuits

Refer to the Block Diagram in Section 7 for an illustration of the functional relationships between system components, and to the complete schematic diagrams in Section 8 for the Amplifier, Power Supply, Regulator and Display Boards.

Primary Circuit and Regulator Board

The amplifier is fused with an MDA 12 amp fuse on the 115 V units and an MDA 6-1/4 amp fuse on 230 V units.

The amplifier is thermally protected by a heatsink mounted 100° C self-resetable thermal breaker in series with the transformer primary. Later versions of the TFM-42/45 also have an internal 150° C resetable thermal switch inside the transformer, in series with the primary.

A line filter minimizes normal and common mode noise on the AC line between 0.15 and 30 MHz. It is also used to suppress noise generated by the triac conduction from the AC line.

A voltage conversion switch rewires the transformer primary from a parallel to a series configuration for 230 V operation.

Start-up Sequence

The phase shift voltage at the junction of R8 and R2 is obtained through the heatsink thermal switch and is approximately 110-120V, regardless of whether the switch is in the 115V or 230V position.

The power switch on the front of the amplifier opens the connection from S to K on the Regulator Board, preventing the phase shift voltage from reaching the triac control circuit. (Note: The M-4.0t and TFM-4.0 use a different method of turning on the amplifier. When the power switch is off, it shorts the connection between D and E on the Regulator Board, preventing the phase shift capacitor C4 from charging up.) Once the power switch is turned on, capacitor C4 begins charging up through R8 and either Q2 or Q3, depending on the polarity. The positive half-cycle of the AC line will charge C4 through R8 and Q3. This charging current forward biases the base emitter junction of Q3, causing it to conduct. Q3 turns on Q4, but no gate current can flow because D6 is reverse biased. C4 continues charging until the charge on C4 exceeds the now falling voltage at the junction of the bases of Q2 and Q3, formed by divider R8 and R9. Q3 and Q4 will turn off and C4 will begin to discharge through Q2 because the junction of R8 and R9 is more negative than the emitter of Q3 (C4). Q2 will conduct and turn on Q1, and gate current will flow through forward biased D5, firing and latching the triac. On the negative half cycle, C4 is charged through Q2 and discharged through Q3, Q4, D6 and R10 into the gate of the triac. The triac begins to conduct at a minimum phase angle and applies 30-40 VAC to the primary of the transformer.

The triac is switched on and off every half-cycle of the 60Hz AC line. Thus, the triac switches the AC line current off at a rate twice the line frequency, at the instant the line current crosses the zero axis. The triac will then remain off for a number of degrees of the sinusoid, before switching on again. The phase angle at which the triac switches on is the "firing angle" of the triac.

This produces enough voltage to the primary of the power transformer to allow the secondary regulator stage on the power supply board to begin to operate.

Power Supply Regulation

The firing angle of the triac controls the voltage on the primary of the transformer, and is determined by the conduction of the optocoupler U1 on the Regulator Board.

As the conduction of the optocoupler increases, the amount of phase shift on C4 decreases, which increases the conduction angle of the triac. The phototransistor conduction of the optocoupler is controlled by the current through the LED portion of the optocoupler. This LED current is supplied by U1-7 on the power supply board. This differential amplifier senses the secondary supply voltages through R1, R4, R5 and R7. The output voltage at U1-7 increases at the rate determined by C3 (slow start-up). The photo-transistor in the optocoupler will begin to conduct and charge C4 on the regulator board at a faster rate through R2 and D1/D4 or D2/D3 "steering" diodes, depending on the polarity. This decrease in phase shift results in a longer triac conduction time and higher secondary voltages. The idle secondary voltages are set by RP1 on the power supply board.

Load Regulation

When either amplifier channel, or both are driven into a load (8 or 4 ohm), the DC supplies (rail voltages) will begin to "sag". Differential amplifier U1-1 senses this and increases the LED current to the optocoupler. This action increases the phototransistor conduction, which increases the triac conduction, which increases the primary voltage, which increases the secondary voltages, thus providing steady, regulated DC supplies for the amplifier stage.

Secondary Voltages

The secondary winding of the power transformer has three taps that supply the three pairs of DC supply voltages (+/-118V, +/-67V, +/-31V), each having its own bridge rectifier and filter capacitors.

Parallel load resistors R43 and R51 on the 31V bridge rectifier insure that the triac remains latched by providing primary holding current after the secondary supply rectifiers stop conducting.

Parallel load resistors R69 and R70 (TFM-45 only) load the -31Vdc supply to compensate for the added load of the meter lights on the +31Vdc supply. This allows for symmetrical discharging of the power supply at turn off, to minimize thumping or popping.

The +/-11.4Vdc supply are derived from the +/-31Vdc supply, and regulated by Q9, Q10 and zener diodes D22 and D23. Resistors R44, R46, R49 and R54 provide a residual DC voltage after the unit is turned off, thus keeping the front end of each amplifier biased up to prevent excessive thumping. The +/-11.4Vdc supply powers the op-amps and small-signal transistors.

The +/-13Vdc supply is also derived from the +/-31Vdc supply, using R48 and R50 to drop the 31V supply down. The +13Vdc is further regulated by zener diode D28 (not present in models M-4.0t and TFM-4.0). The value of R48 varies depending on the model due to differences in load current from the +13V supply. The +/-13Vdc supply powers the meter boards only.

Amplifier Stage:

Two standard phono jacks on the power supply board are capacitively coupled to the amplifier boards. The left channel has a unity gain inversion stage that is selectable by Switch S1-1, located on the power supply board and accessible through a hole in the rear panel. This switch allows the unit to be used in a mono-bridged configuration.

Both channels have an N-channel FET (Q1) that mutes the input approximately -30dB during turn-on or during a fault condition. The FET's share a common drive circuit that is located on the power supply board.

Input buffer U1 is a TL081 operational amplifier, which provides a high input impedance and a low output impedance for driving the clipping LED circuit (Headroom Exhausted LED's; not present on the TFM-45), and the succeeding amplifier stage. Local negative feedback from the output of U1 via R14 and C15 is used for stability and to reduce overall negative feedback.

The output of the input buffer U1 is coupled to Q2 and Q3 provide DC-level shifting. This is required for referencing the audio signal to the top DC supplies to drive the next stage.

The output of the DC-level shifters drives a pair of predriver voltage amplifiers (Q4 and Q7). This stage provides full voltage swing to the following current gain stages and also provides "tracking" to the commutator circuits.

The bias network of Q5 and Q6 provides adjustment of the DC idle current through outputs Q20 and Q22. Q6 is mounted on the heatsink and provides feedback to prevent thermal runaway and helps maintain a constant idle current. RP1 adjusts the idle current by varying the base voltage at Q6.

The predrivers (Q4 and Q7) drive the "driver" stage (Q11 and Q12), which in turn provides current amplification for driving the outputs and supply commutating circuitry.

Q9 and Q10 limit the current available to the base of the drivers. These transistors are biased on by the voltage drop across the output emitter resistors, R94 and R95. When Q9 is conducting, it provides a shutdown signal to the power supply board and mute circuitry. (See High Frequency Output for details.)

Current from Q11 and Q12 drives the two high gain, high-linearity output devices Q20 and Q22. These devices provide full voltage swing and current drive to the loads.

The active, local bias network of Q21, R87, and R88, provides variable "pull down" of the bases of Q20 and Q22 to help prevent common-mode conduction of the output transistors and reduce their turn-off time.

The TFM circuitry is composed of IC U2, which detects the output current by differentially detecting the voltage drop across R97. When an 8 ohm load is connected to the amplifier output, the output of U2 reduces the overall gain of the amplifier by approximately 0.88dB. At higher frequencies, C7 compensates for amplifier phase shift. When an 8 ohm load is connected, an additional 0.22dB is dropped across the 0.2 ohm 20W output resistors for a total attenuation of 1.1dB.

Power Supply Commutators

The first supply commutator transistors, Q19 and Q23, are used to increase the supply voltages on the collectors of Q20 and Q22 from 31 V to 67 V as required.

The diode network of D18, D19, and D20 (and their negative equivalents), on the base of Q20 and Q22, provides voltage "lead" for the first supply commutating transistors (Q19 and Q23). This allows the supply voltages to anticipate audio demand. As frequency increases, Q19 and Q23 require additional "lead" time to stay ahead of the audio. This is achieved by C22, R60 and D17 (and their negative equivalents). D29 and D30 prevent the first commutator from dumping back into the 31V supply.

The second supply commutator pairs (Q17 and Q18, Q24 and Q25) increase the supply voltages on the collectors of Q19 and Q23 to increase Q20 and Q22 collector voltages to 118 V (no load), as required.

The second commutators receive their drive from drivers Q14 and Q16. However, the current gain at this stage is insufficient to supply enough current to the output transistors, and a bootstrap network and current gain stage are required. The main bootstrap network consist of R49, R52, R62, and C19 (and their equivalents on the negative side).

The turn-on threshold for the second commutators is determined by the DC biasing on the base of Q13 and Q15.

D28 and D31 provide supply steering which prevents the commutators from dumping back into the 67V supply.

Protection Circuitry

Protection functions are shared by the amplifiers and the power supply. Active shutdown protection is provided for the following faults.

OVER CURRENT:

The amplifiers are protected from short-term excess current through the output stage by electronic current-limiters. When the current through the output transistors becomes excessive, the voltage drop across the emitter resistors R94 and R95 bias the current limiter transistors Q9 and Q10 on, which shunt the drive current via D7 and D9. Q9 provides base current for Q2 on the Power Supply Board through D8 and R37, which drives Q3. Q3 then charges C11 and turns on Q8, which supplies a negative turn-off voltage to the input muting FET's on the amp boards. This attenuates the input signal, removing the high current condition, turning off all but Q8, which turns off about four seconds later, after C11 discharges through R35 and R34; thus turning off the muting FET's and allowing signal to pass. In this way, the short circuit current is briefly limited to 16 amps until the mute circuit is activated. R56, D13, R57 and D14 determine the V-I limits. The limiters should not activate into loads of 2 ohms or greater with no more than 45 deg phase shift.

Q3 also biases on Q1 (M-4.0t and TFM-4.0 only), lighting the Protect LED. C4 is also charged and continues to provide base current to Q1, keeping the LED lit during the mute time.

DC OFFSET:

DC offset is sensed by a low-pass differential amplifier located on the power supply board, formed by U1-pins 2 and 3. Left and right amplifier outputs are summed by R22 and R23, and capacitor C6 rolls off the output in the audio spectrum while +/- DC offset and single channel low frequency signals below 5 Hz are amplified. If pin 1 goes positive, current through D6, R18, and U1-6 drives the output of U1-7 negative. This reverse biases the optocoupler LED on the Regulator Board and forces the conduction angle of the triac back to its initial startup position, thereby lowering all secondary power supply voltages and insuring the offset is held to a minimum value.

HIGH FREQUENCY OUTPUT:

The amplifier is not designed to protect the speaker at frequencies below 6 KHz. The amplifier drives to clipping at 10 KHz. At 20 KHz the amplifier drives to approximately 49 Vrms, or 1dB below clipping. C11 on the Amplifier Board forward biases limiter transistor Q9 during negative transitions. Q9 provides base current for Q2 on the Power Supply Board, thus initiating the input muting circuit. This attenuates the high-frequency signal, allowing the mute circuit to reset after a few seconds.

LOW-LEVEL SUPPLY:

D2 and D3, on the Power Supply Board, insure that the output of U1-7 never goes to its maximum positive state if the -11.4V or -13V DC supplies are shorted out.

If the output of U1 were to reach its maximum (+10 to +11V DC) at idle, the triac would shift to its maximum conduction angle and cause overvoltage in the 115V, 67V, and 31V DC supplies.

Any +11.4V DC supply fault causes DC offset at the amplifier output. (See DC Offset for a full description of the protective mechanism involved.)

OVERHEATED OUTPUT TRANSISTORS:

A 100° C resetable thermal switch, in series with the AC line, protects the output transistors if the top cover vents are blocked or if the unit is run with excessive continuous sinewaves.

OVERHEATED TRANSFORMER:

In later versions of the TFM-42/45, a 150° C resetable thermal switch is located between the primary and secondary windings of the power transformer. This switch protects the transformer when the amplifier is overfused or has a major fault condition.

MAJOR FAULTS:

The slo-blo line fuse protects the unit from further damage when a major fault such as a shorted triac, shorted transformer, or a major secondary power supply fault occurs.

If the unit is run at or near its rated power, the fuse eventually blows. The rated line fuse allows the unit to be operated without interruption for all musical applications.

Display Board:

(for the M-4.0t, TFM-4.0, & TFM-42)

The display consists of two columns of seven LED's each. The LED's in the left column monitor the peak output of the left channel. Similarly, the right-hand LED's monitor the right channel. In the following description the LED's are numbered from one to seven, bottom to top.

LED 1 indicates that power is on and the amplifier is ready for operation.

LED's 2 through 6 indicate power levels with a 1ms attack and 500ms decay.

This display operates by incorporating a series of four comparators and a resistive ladder network which sets the appropriate reference voltages for each stage.

The Level LED display is driven directly from the amplifier outputs, with the attack and decay ballistics provided by D12, D13, R40, R41, C12, and C13.

LED 7 indicates the presence of distortion in excess of 1%.

The Clip LED drive transistors (Q4, Q5, Q6, Q7) are driven off the negative-going error output signal from U1 on the Amplifier Boards.

Analog Meter Display:

(TFM-45 only)

The meter drive PCB provides electronic meter calibration via VR401 & VR402. If mechanical meter alignment is needed to obtain a 0 wattage reading with no signal, then remove the two screws on the meter bracket and lift out both meters.

At the bottom center of the front panel of the meter is the mechanical movement alignment point. At full power adjust the meter pointer to the 375 watts position (looking straight in at meter).

The electronic meter calibration is done as follows:

A) Set the input signal levels for 54.8Vrms output into an 8 ohm load on both channels.

B) Adjust the trim pots on the meter drive PCB (located on the front panel) for a reading of 375 Watts on the meters.

M-4.0/TFM-4.0

LED#	8Ω	4Ω	Bridged
7	600	700	1000
6	240	480	800
5	120	240	480
4	60	120	240
3	30	60	120
2	15	30	60
1	0	0	0

TFM-42

LED#	8Ω	4Ω	Bridged
7	600	700	1000
6	100	200	400
5	50	100	200
4	25	50	100
3	15	30	60
2	8	15	30
1	0	0	0

Approximate power levels (in watts) for LED turn-on

SECTION 5

TEST PROCEDURE

M-4.0t, TFM-4.0, TFM-42, TFM-45

Use the test procedures described in this section to determine the overall performance of the amplifier. Before beginning the test, read the troubleshooting section to review the types of problems that may be identified by the test. Steps 7 and 8 of the procedure must be completed to ensure the unit meets safety requirements.

If you do not understand any of the following procedures, or if you do not have the equipment required to complete the tests, please contact the factory.

Required Equipment:

Oscilloscope(s)

Note: We recommend the use of two scopes. One scope should be isolated, with no secondary ground reference. Use this scope to observe triac waveforms on the AC line. The second scope can be used to observe the amplifier output and for secondary troubleshooting.

Distortion Analyzer

Variac, 20-30 amp

AC line current monitor

AC line voltage monitor

Two 8 Ω load resistors, 500W each

Digital voltmeter

AC voltmeter

Safety Analyzer (Hi-Pot Tester)

Presets:

Follow the procedure described below to power up a damaged unit:

- A) Connect an input cable to each channel's input jack from the distortion analyzer signal output (set to 2kHz).
- B) Set the Variac to minimum.
- C) Set RP1 on the Power Supply Board for minimum VDC (turn the potentiometer fully counter-clockwise).
- D) Set RP1 on the left and right Amplifier Boards for minimum idle current (turn the potentiometer fully clockwise).
- E) Set the Audio generator to minimum.

Step-by-Step Procedure:

CAUTION

All primary waveforms must be viewed with an isolated, line triggered scope with no secondary ground reference.

Step 1. Bring the variac up slowly to approximately 60 VAC line (or to 120 VAC for 230 V units).

- A) AC current flow in line should be less than 0.25 amps.
- B) All front panel LEDs should be off.
- C) The start up voltages should be as follows:
 - 1) Approximately 20 Vdc for 118 Vdc supplies
 - 2) Approximately 2-3 Vdc for 11.4 Vdc supplies.
- D) Check amplifier channels outputs for DC offset less than 100 mV.

Step 2. Bring up the variac to approximately 85 VAC line (or to 170 VAC for 230 V units).

- A) Triac fires and there is a momentary surge of current.
- B) Ready LED's should light (Protection LED is off.)
- C) AC current flow in line should be less than 0.5 amps.
- D) Increase audio input to generate a 1 Vrms 2kHz signal at the amplifier outputs. Small cross-over notches should be present on sine wave output.
- E) Check triac firing for good symmetry.
- F) Check all VDC supply levels for power supply regulation:
 - 1) 118 VDC supplies should be approximately 92 VDC.
 - 2) 67 VDC supplies should be approximately 51 VDC.
 - 3) 31 VDC supplies should be approximately 23 VDC.
 - 4) 11.4 VDC supplies should be approximately 11.4 VDC.
 - 5) 13 VDC supplies should be approximately 8-9 VDC.
- G) Amplifier offset should be less than 30 mV.

Step 3. Increase Variac to 120 VAC (or 230 VAC for 230 V units).

- A) AC current flow should be less than 1.0 amp.
- B) 118 VDC supply should be approximately 97 Vdc.

Step 4. Adjust RP1 on the Power Supply Board to obtain a top rail voltage of 118Vdc.

- A) Observe normal triac idling conduction at MT2 (See Figure 1).

Step 5. Set Amplifier Idle Current.

Note: This adjustment should be made after the unit has been on at least two minutes at idle.

- A) Turn off the input signal. Verify no loads are connected to the outputs.
- B) Adjust RP1 on the left Amplifier Board for 2.5mV across both 0.05Ω, 5W emitter resistors, R94 and R95.
- C) Repeat Step 2 for the right channel Amplifier Board.

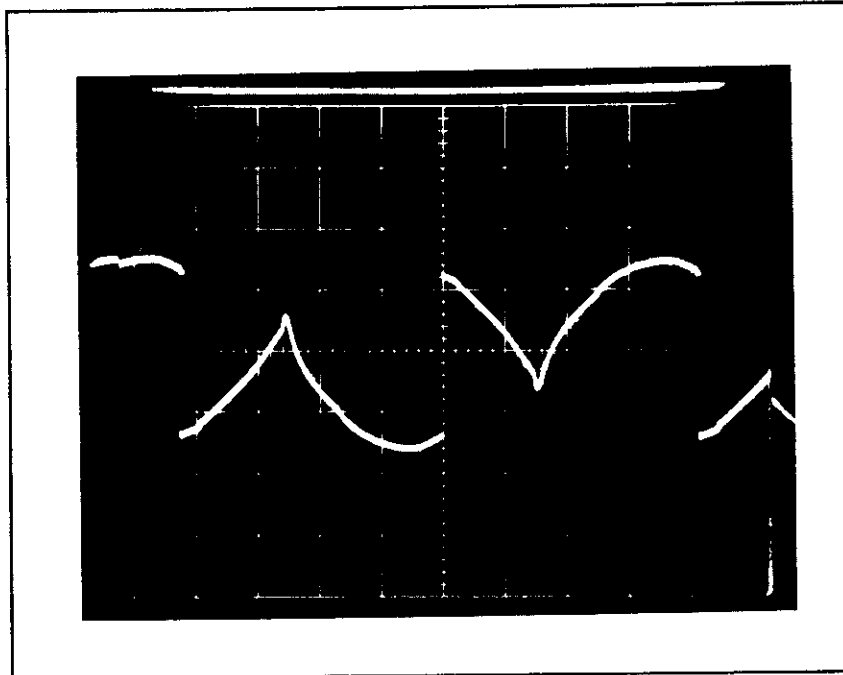

Figure 1: Triac conduction at idle, viewed at MT2.
(50V/div. Vertical; 2mS/div. Horizontal; Line Sync)

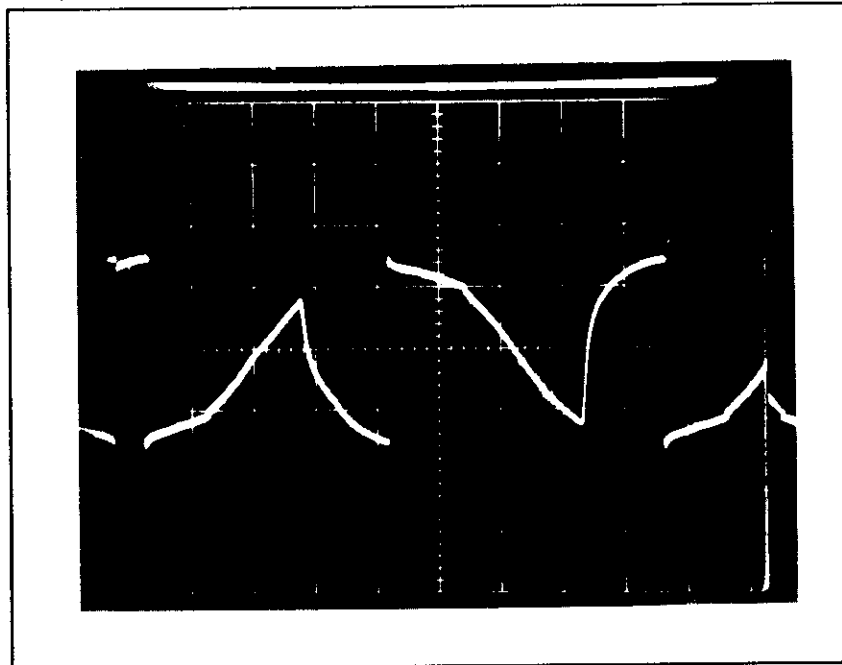

Figure 2: Triac conduction at full power, viewed at MT2.
(50V/div. Vertical; 2mS/div. Horizontal; Line Sync)

Step 6. Amplifier Boards.

A1) Adjust damping (TFM-42/45 only)

- 1) Connect an 8Ω load to the output of each channel.
- 2) Adjust the signal generator to produce a -29dBV (35.5mV rms) signal at 2kHz.
- 3) Adjust RP2 on each amp board to produce a 0dBV (1Vrms) output into an 8Ω load.

A2) Check Gain (M-4.0/TFM-4.0 only)

- 1) Adjust the signal generator to produce a -29.5dBV (34mV rms) signal at 2kHz.
- 2) Verify the output of both channels is 0dBV (± 1dB) into an 8Ω load. Left and Right channel outputs should be within 1dB of each other.

B) Check frequency response:

- 1) Set output reference to +10dBV (3.16Vrms) at 2kHz.
- 2) Check response at 20Hz and 20kHz (+0, -0.5 dB). See Figure 3.
- 3) Check mono switch for phase inversion of the left channel.

C) Verify separation at +10dBV, 2kHz is less than -45 dB.

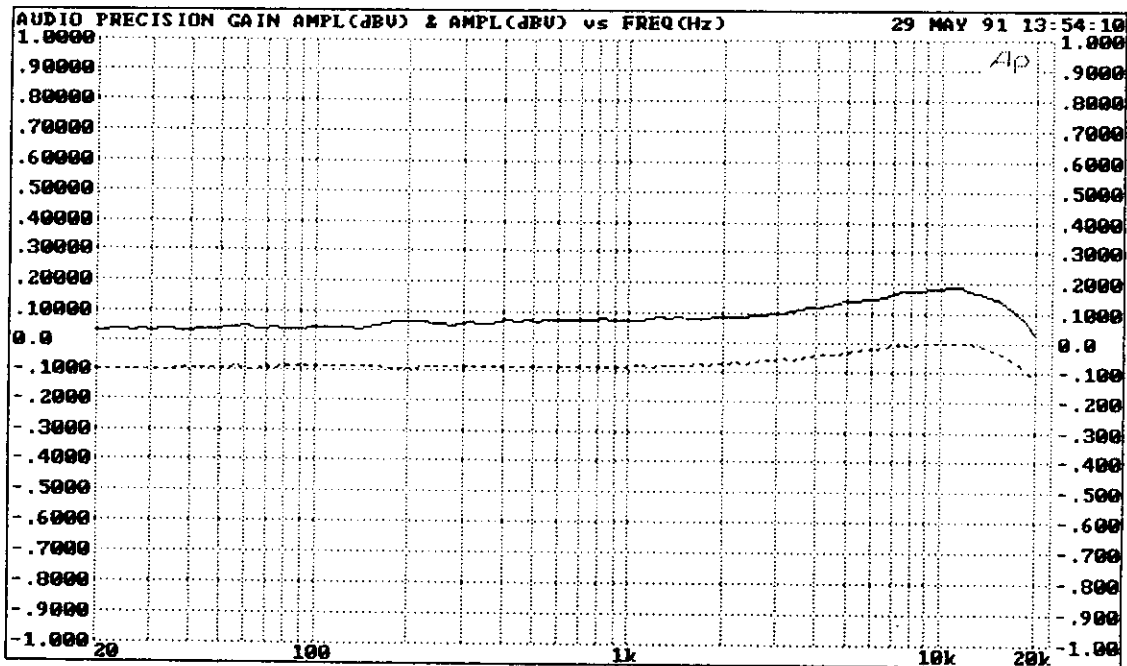

Figure 3: Frequency Response (Left Channel ———, Right Channel -----)

D) Check damping at 2kHz. Output should drop 1.0dB (± 0.1 dB) from no load to 8 ohm load.

E) Increase amplifier output to 54.8 Vrms (375W/8 ohms). Left and right channel commutators should appear as in Figure 4 at 2kHz.

NOTE: The AC line current will exceed the rated value of the line fuse when both channels are driven to full power. Since the fuse is slow-blowing, it can withstand the higher current for a few seconds before blowing. Therefore, these tests should be performed quickly to avoid blowing the fuse.

It may be necessary to temporarily replace the 12A line fuse with a 15A slo-blow fuse.

DO NOT forget to return the 12A fuse after completing these tests!

F) Check full power with both channels driven into 8 ohms at 2kHz (see Figure 5).

NOTE: A sufficiently low-impedance AC supply is required to achieve low distortion measurements at full power. If the AC line voltage "sags" at full power, it may be necessary to increase the Variac to bring the line voltage back up to 120VAC.

- 1) Note the maximum triac conduction angle at MT2, as shown in Figure 2.
- 2) Distortion at 375 watts per channel (54.8 Vrms) should be less than 0.2%.
- 3) Repeat at 20Hz and 10kHz.
- 4) Increase output to 405W (57 Vrms) and verify symmetrical clipping on the positive and negative peaks of the waveform.

G) High-Frequency Shutdown

- 1) Turn signal generator down and set to 20kHz. Slowly increase the input to the left channel and verify the output exceeds 40Vrms before the amplifier mutes (typically at about 50Vrms output).
- 2) Repeat for the right channel.

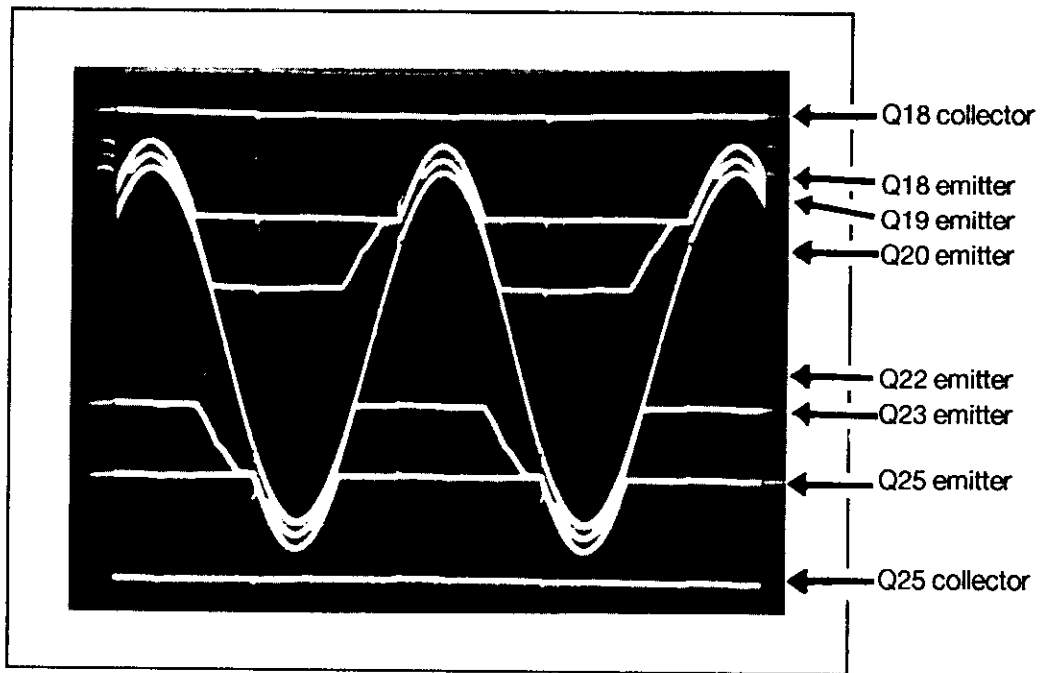

Figure 4: Commutators

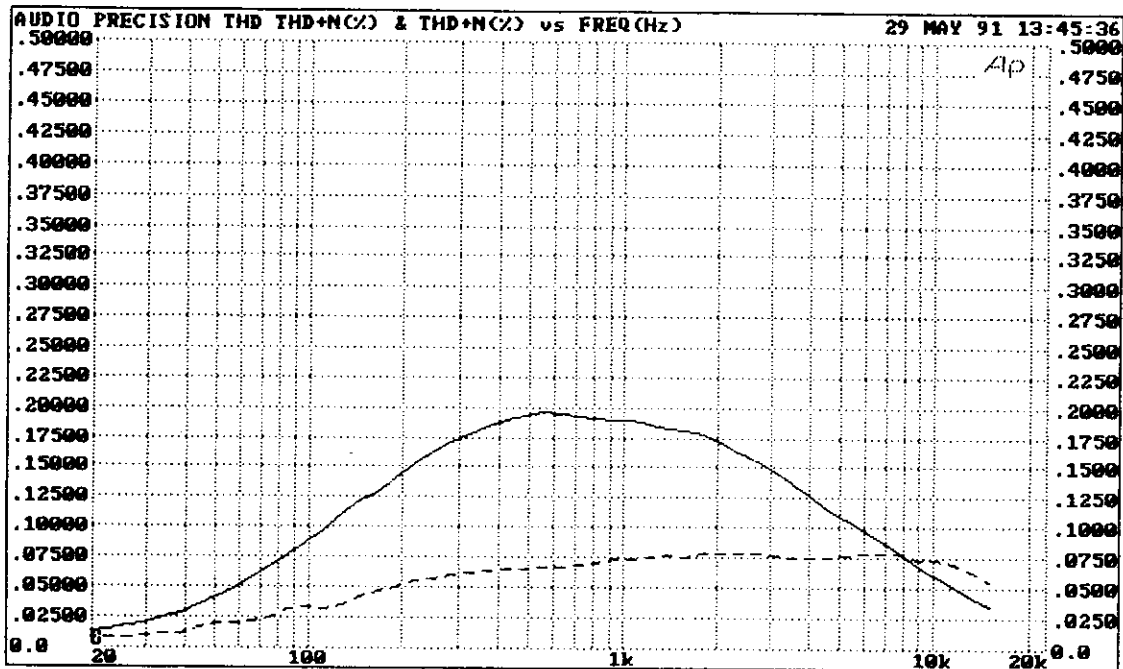

Figure 5: THD (A-weighted) vs. Frequency at full power (375W/8Ω)
(Left Channel ———, Right Channel -----)

H) Short circuit protection:

- 1) Drive both channels at 2kHz to a 20 Vrms output.
- 2) Short left channel output to ground.
 - a) The amplifier should mute both channels immediately, and the protection LED should light.
 - b) One mute cycle should last approximately 4 to 6 seconds. Normal operation should return when short is removed.
- 3) Repeat Step 2 for the right channel output.

- I) DC fault protection:
 - 1) Short out the cathode of D22 on the Power Supply Board to ground. The amplifier should mute both channels and the Triac conduction angle should shift back to its startup position. The Protection LED will light on M-4.0t and TFM-4.0 models.
DC offset on both channels should be less than 10 Vdc.
Normal operation should resume when the short is removed.
 - 2) Short the anode of D23 on the Power Supply Board to ground. Verify same results as the previous step.
- J) Retest amplifier output:
 - 1) Check right and left channel outputs and displays from 0V to clip.
 - a) Display LEDs should be no more than ± 1 LED difference.
 - b) Check scope for the absence of distortion.
- K) Noise, with inputs shorted:
 - 1) Left and right channel noise A-weighted should be less than 110 dB below rated power (< 175 μ V) or less than 95dB below rated power unweighted (less than 1.0mV unweighted).
- L) Check turn-off and turn-on thump, and turn-on delay.
 - 1) Drive both channels at 2kHz to 0dBV output.
 - 2) Turn the amplifier off and verify a thump of less than 2Vrms (monitor for at least ten seconds).
 - 3) Turn the unit back on and verify less than 1Vrms thump, and the signal reappears between 4 - 10 seconds.
- M) Meter Calibration (TFM-45 only)
 - 1) With no input signal verify both meters read zero.
 - 2) Set the input signal level for 54.8Vrms output from the left channel into 8 ohms (375W/8 Ω).
 - 3) Adjust the pot (VR401) under the edge of the meter driver board for a reading of 375 watts on the meter.
 - 4) Repeat for the right channel, adjusting with VR402.
 - 5) Check that both meter lamps are lit and that the dimmer control operates properly (fully CCW is dim, full CW is bright).

Step 7. Line Leakage:

Before returning the unit to the customer, one of the following safety tests must be performed.

- A) Disconnect all signal path inputs and outputs.
- B) Connect the unit to 120 VAC supply and turn the power switch "ON". Using an ammeter, measure the current between each side of the linecord and chassis ground of the unit under test. If leakage current exceeds 0.5mA, the unit is defective.
- C) Measure the resistance from either side of the linecord to chassis ground. If it is less than 500k Ω , the unit is defective.

WARNING - DO NOT return the unit to the customer if it fails one of these tests until the problem is located and corrected.

Step 8. Dielectric Breakdown:

With an approved safety analyzer (Hi-Pot tester), verify that the unit can withstand application of a 1000 VAC signal for at least one second. Apply the signal between either side of the line and an exposed ground on the unit. The power switch should be ON.

SECTION 6

TROUBLESHOOTING GUIDE

The M-4.0t, TFM-4.0, TFM-42 and TFM-45 amplifiers are more complex than conventional amplifiers. This guide will help service technicians isolate and repair electrical faults in the amplifier.

Major faults should be investigated with the loads removed.

CAUTION:

All primary waveforms must be viewed with an isolated, line triggered scope with no secondary ground reference.

Fault 1: No Power.

No LED's Light at 120 VAC Line.

No AC Current.

- 1) Determine if AC line voltage is reaching the triac.
Use AC voltmeter from MT1 to MT2 on triac.
- 2) If AC is not present on triac:
 - a) Check fuse and fuse holder.
 - b) Check line cord.
 - c) Check voltage conversion switch on regulator board.
 - d) Check primary winding of transformer for continuity.
- 3) If AC is present across triac (MT1-MT2), but triac is not firing:
 - a) Check for phase shift voltage across C4 on regulator board.
 - b) If voltage is not present, either:
 - * The Power Switch is shorted (M-4.0t, TFM-4.0 only).
 - * Resistor R8 is open on the Regulator Board.
 - * Q2 and Q3 are defective on the Regulator Board.
 - * Check thermal switch on heatsink (normally resets after cooling).
 - c) If voltage is present, either:
 - * The triac is defective.
 - * Q1 and Q4 are open on the Regulator Board.
- 4) Triac fires and the voltage at C4 is less than 4 Vrms.
All power supplies remain low.
 - a) Check for shorted output transistors or driver transistors.
 - b) Opto-coupler CNY17-2 is defective.
 - c) D1 through D4 are defective on the Regulator Board.
 - d) U1 is defective on the Power Supply Board.
 - e) See Fault 4.

Fault 2: Greater Than 1 Amp AC Line Current Draw With Small Variac Rotation.

- 1) Check the following primary components:
 - a) Triac
 - b) Power transformer
 - c) Line filter
 - d) Voltage conversion switch
- 2) Check scope isolation.
- 3) Proceed to next section.

Fault 3: All LED's Fail to Light.

AC Line Current Greater Than 1 Amp After Triac Firing.

NOTE: This condition means that a current drawing fault exists on either the Power Supply Board or one or both Amplifier Boards. If only one channel is offset, then the fault is probably an amplifier board problem. If both channels are offset, then the fault is probably a common power supply fault.

Troubleshooting under these conditions can be simplified by shorting across the triac with a jumper wire. This bypasses the triac control and allows 100% of the line voltage to be applied to the transformer. Therefore, never increase the line voltage beyond about 60 VAC when the triac is bypassed.

Use Extreme Caution. Be sure the variac is turned all the way down, or better yet, unplug the amplifier from the variac. Short across MT1 and MT2, the cathode and anode of the triac. Do not short the gate of the triac or you may damage the triac and associated circuitry.

- 1) If the Amplifier channels are not offset:
 - a) Check 125 V supply capacitors and rectifiers.
 - b) Check 67 V supply capacitors and rectifiers.Observing excessive ripple voltage on any DC supply can help locate which supply is faulty.
- 2) If both channels are offset:
 - a) and the offset is positive:
 - * D23 is shorted on the Power Supply Board.
 - * C17 is shorted on the Power Supply Board.
 - * D14 and D15 are shorted on the Power Supply Board.
 - * C14 is shorted on the Power Supply Board.
 - b) and the offset is negative:
 - * D22 is shorted on the Power Supply Board.
 - * C16 is shorted on the Power Supply Board.
 - * D16 and D17 are shorted on the Power Supply Board.
 - * C15 is shorted on the Power Supply Board.
- 3) If one channel only is offset.
 - a) and the offset is positive:
 - * Q20, Q11, or Q21 is defective on the Amplifier Board.
 - * Q6 or Q5 is defective on the Amplifier Board.
 - * Check the predrivers Q4 and Q7 and associated resistors and diodes.
 - * The mica insulator on the Amplifier Board is defective or missing.

b) and the offset is negative:

- * Q22, Q12, or Q21 is defective on the Amplifier Board.
- * Q6 or Q5 is defective on the Amplifier Board.
- * Check the predrivers Q4 and Q7 and associated resistors and diodes.
- * The mica insulator on the Amplifier Board is defective or missing.

Fault 4: LED's Not Lit.

AC Line Current Draw is Less Than 1 Amp.

1) If one channel is offset.

a) and the offset is positive:

- * U1 is defective if the output is positive and if pin 3 is at ground and pin 1 of U2 on the Amplifier Board is at ground.
- * U2 is defective if pin 1 or pin 7 is offset on the Amplifier Board.
- * Q2 is shorted or Q3 is open on the Amplifier Board.
- * Q4 is shorted or Q7 is open on the Amplifier Board.
- * R34 is open.

b) and the offset is negative:

- * U1 is defective if the output is negative and if pin 3 is at ground and pin 1 of U2 on the Amplifier Board is at ground.
- * U2 is defective if pin 1 or pin 7 is offset on the Amplifier Board.
- * Q3 is shorted or Q2 is open on the Amplifier Board.
- * Q7 is shorted or Q4 is open on the Amplifier Board.
- * R32 is open.

Fault 5 : LED's Lit.

Power Supply Regulating. No Signal Amplification.

1) No output on either channels.

a) Mute drive defective.

- * Q8 on the Power Supply Board is open.
- * Q2 on the Power Supply Board is shorted.
- * Q1 on the left and right Amplifier Boards is shorted.

b) Defective current limiters.

- * Q9 on the left or right Amplifier Board is shorted.
- * D7 on the left or right Amplifier Board is shorted.
- * R94 or R95 have changed value or opened.

2) No output on one channel.

a) Mute FET Q1 is defective.

b) A bad solder joint at C3.

c) R3 is open.

d) Bad solder joint on the input jacks.

e) R97 is open.

f) 0.2Ω 20W Resistor (binding post) open.

Fault 6: Distorted Amplification One Channel (Commutation and Power Supply Fault)

- 1) First commutator is not supplying sufficient drive to the outputs:
 - a) Q19 or Q23 on the Amplifier Board is defective.
 - b) Either D29 or D30 is shorted. (This short causes the commutator current to flow back into the supply rather than to the output transistors.)
 - c) Insufficient voltage lead for the first commutator.
 - * Either D18, D19, D20, D21, D22, or D23 is defective.
- 2) Second commutator is not supplying sufficient current to the outputs.
 - a) Either Q17, Q18, Q24, or Q25 is defective.
 - b) Insufficient drive to Q17, Q18, Q24, or Q25:
 - * Check drive transistors Q13, Q14, or Q15, Q16.
 - * Check bootstrap network D12, D35, C19, R49, R52, R62, or D15, D36, C20, R61, R65.
 - * Either D28 or D31 is shorted. (This short causes second commutator current to flow back into the 71 V supply instead of to the output transistors.)
 - c) Current limiters are defective.
 - * Check D7, Q9 or Q10, or D9.
 - d) Drive circuitry is defective.
 - * Check drivers Q11 and Q12.
 - * Check R36 and R40.
 - * Check predrivers Q7 and Q4.
 - * Check fusible resistors R32 and 34.
 - * Check fusible resistors R35 and R41.
 - * Check D6 and D10.
 - * Check Q2 and Q3.

Fault 7: Drives No Load Ok. Distorts Into 4 Ω or 8 Ω Load.

- 1) Defective drive resistors on the Amplifier Board.
 - a) Check R36, R40, R35, R41, R32, and R34.
 - b) Check R23 and R26.
- 2) Overheated emitter resistors.
 - a) Check output emitter resistors R94 and R95.
 - b) Check commutator emitter resistors R84, R93, R92, and R96.
- 3) Leaky current limit transistors.
 - a) Check Q9 and Q10.
- 4) Defective commutator transistors.
 - a) Check Q17, Q18, Q24, Q25, Q19, Q22.
- 5) Defective commutator drive resistors.
 - a) Check R66, R74, R73, and R82.
 - b) Check R49, R52, R62, R61, and R65.
- 6) If both channels are distorted, check the power supply rectifier.
 - a) Check BR1 for one diode open.
 - b) Check D14, D15, D16, and D17 for open.
 - c) Check D18, D19, D20, and D21 for open (or BR2 in later versions of the TFM-42/45).

Fault 8: Incorrect Damping

- 1) 0.2Ω 20W resistor in series with output is defective.
- 2) R97 on the Amplifier Board is defective.
- 3) U2 or R6-R15 is defective.
- 4) RP2 is misaligned on the amplifier board (except early versions of M-4.0t).

Fault 9: Excessive Noise

Note: With both inputs open, the right channel normally has more noise than the left channel. When the inputs are shorted or terminated, both channels are equally quiet.

- 1) Bad TL081 op-amp (U1) on the Amplifier Board causes "hiss" or "popcorn" noise.
- 2) Secondary leads from transformer are not routed downward close to the chassis.
- 3) Improper grounding.
 - a) Signal ground and power supply ground are connected somewhere in addition to the common grounding point on the power supply.
 - b) Transformer center tap (black wire), +118 V caps ground (black wire), speaker ground return (black wire) not soldered properly.
- 4) Bad FET Q1 on the Amplifier Board.
- 5) Triac misfiring causes excessive noise.
- 6) See noise reducing modifications in Appendix E, Service Bulletins.

Fault 10 : Excessive Turn Off "Thumps"

- 1) A delayed turn-off thump suggests a defective part in the low DC volt supplies:
 - a) Check R44, R49, R45, R55, R56, Q9 and C16.
 - b) Check R46, R47, R54, R57, R58, Q10 and C17.
- 2) Delayed turn-on and turn-off thumps indicate one of the following:
 - a) Defective TL081 on the Amplifier Board.
 - b) Leaky drivers or predrivers (Q4, Q7, Q11, or Q12).
- 3) For TFM-45 turn-on/turn-off thump, see Service Bulletin TFM-45-6 in Appendix.

Fault 11: High Frequency Oscillation

- 1) Output RC network at binding posts:
 - a) Check 2.7Ω 5W resistor.
 - b) Check 0.33μf 400 V capacitor.
- 2) Check the compensation capacitors, specifically:
 - a) Check C18, C8, C9, and C4.
- 3) Check the feedback networks, specifically:
 - a) Check C15 and R14.
 - b) Check C13 and R39.

SECTION 7

BLOCK DIAGRAM

BLOCK DIAGRAM
M-4.0t, TFM-4.0, TFM-42/45

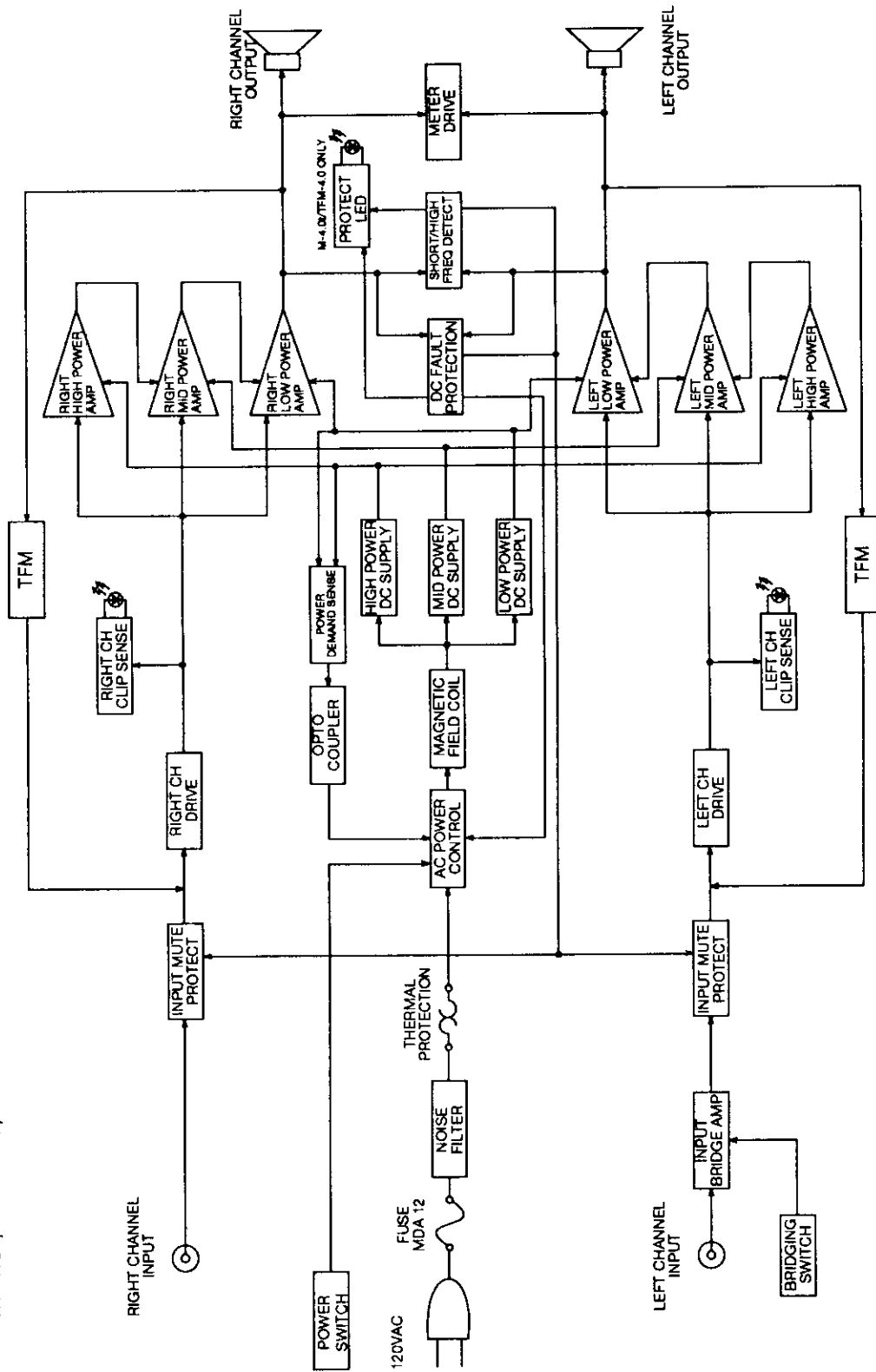

SECTION 8
SCHEMATICS AND LAYOUTS

	Page
M-4.0t Amp Schematic	24
M-4.0t Amp Board Layout	25-26
M-4.0t Power Supply Schematic	27
M-4.0t Power Supply Board Layout	28
M-4.0t Regulator Board Layout	29
M-4.0t Display Schematic	30
M-4.0t Display Board Layout	31
M-4.0t Final Assembly	32-33
TFM-42/45 Amp Schematic	34
TFM-42/45 Amp Board Layout	35
TFM-42/45 Power Supply Schematic	36
TFM-42/45 Power Supply Board Layout	37
TFM-42/45 Regulator Board Layout	39
TFM-42 Display Schematic	40
TFM-42 Display Board Layout	41
TFM-45 Meter Schematic	42
TFM-45 Meter Board layout	43
TFM-42 Final Assembly	44-45
TFM-45 Final Assembly	46-47
TFM-42 Wiring Diagram	48
TFM-45 Wiring Diagram	49

REV	DATE	DESCRIPTION	BY	CHKD
A		RELEASED PRODUCTION		
B		REV E2N1E (P.9)		
C		REV PER E2N1E P.9		
D		REV PER E2N1E P.9		
E		REV PER E2N1E P.9		
F		REV PER E2N1E P.9		
G		REV PER E2N1E P.9		
H		REV PER E2N1E P.9		
I		REV PER E2N1E P.9		
J		REV PER E2N1E P.9		
K		REV PER E2N1E P.9		
L		REV PER E2N1E P.9		
M		REV PER E2N1E P.9		
N		REV PER E2N1E P.9		
O		REV PER E2N1E P.9		
P		REV PER E2N1E P.9		
Q		REV PER E2N1E P.9		
R		REV PER E2N1E P.9		
S		REV PER E2N1E P.9		
T		REV PER E2N1E P.9		
U		REV PER E2N1E P.9		
V		REV PER E2N1E P.9		
W		REV PER E2N1E P.9		
X		REV PER E2N1E P.9		
Y		REV PER E2N1E P.9		
Z		REV PER E2N1E P.9		

NOTES: (UNLESS OTHERWISE SPECIFIED)

1. PARTS LISTED ON FINAL APPROVAL
2. ASSEMBLY DRAWING PER E2N1E P.9
3. ALL ITEMS ARE ON E2N1E P.9 PARTS LIST
4. INSTALL BURN WIRES, ITEM 1046, ON R2Z AS SHOWN PER DETAIL B.
5. APPLY SEALANT, ITEM 1050, AS REQUIRED TO MAKE COMPLETE INSULATION OF ALL BURN WIRES.
6. COMPONENT VALUES OF 1/4 IN OR MORE TO BE MOUNTED ON PCB BY 25 IN.

UPDATED REVISION STATUS TO MATCH DETAIL B. ADD: NOTES 2 THRU 6. IN SECTION A-A, ITEM 1050 WAS: 10 INSECT GUMMERS PER E2N1E P.9

APPROVALS: BY DATE

DESIGNED BY: DATE

CHECKED BY: DATE

APPROVED BY: DATE

DATE: 11/1/68

SCALE: 2:1

REV: 1 OF 1

DO NOT SCALE DRAWING

DATE: 11/1/68

SCALE: 2:1

REV: 1 OF 1

SECTION A-A

125

250

SECTION A-A

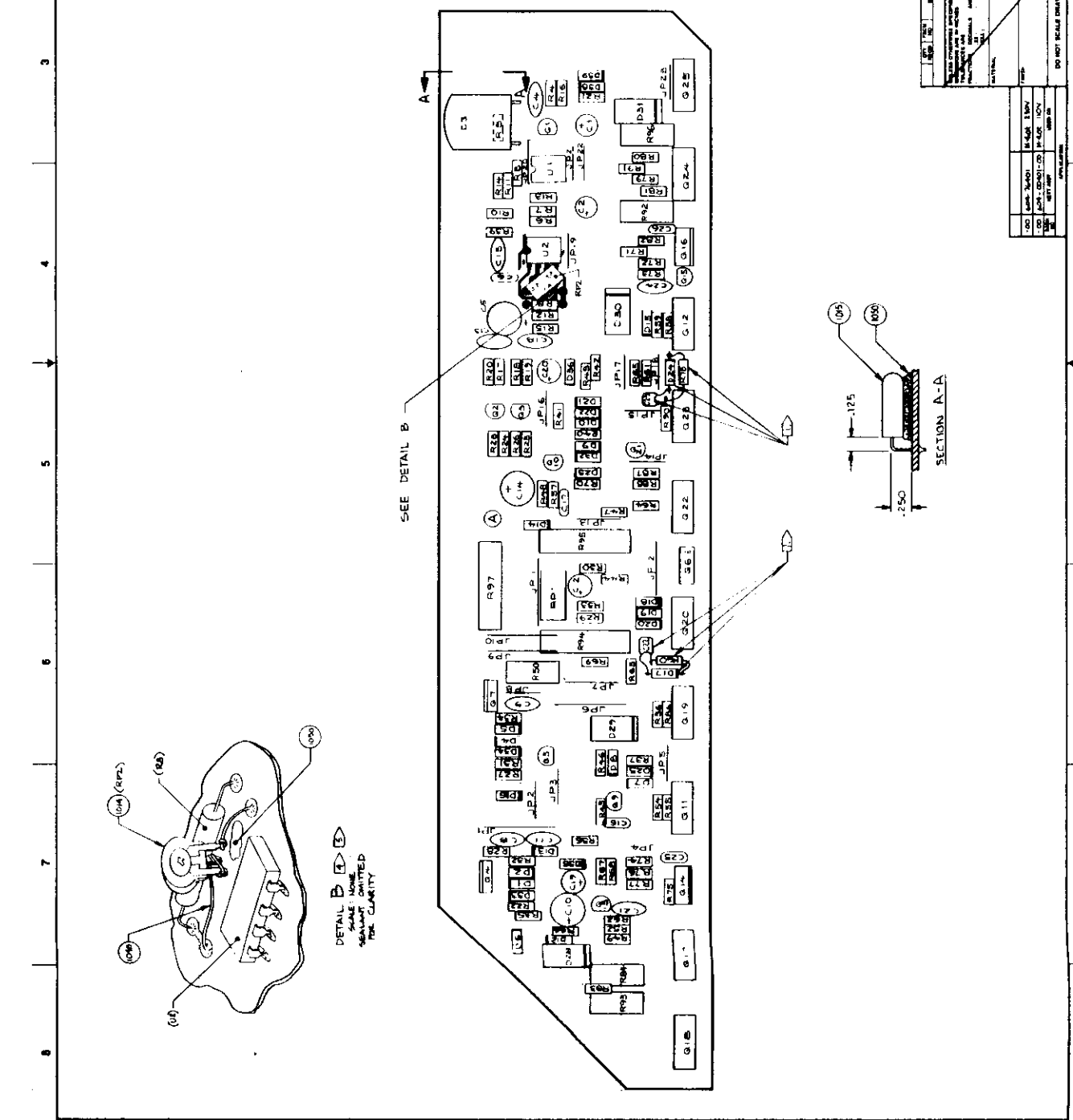

602-00576-00		1	G
REV	DATE	BY	
1	12-10-81	JLL	
INTEGR. CHANNELS PER ECO # 1319			

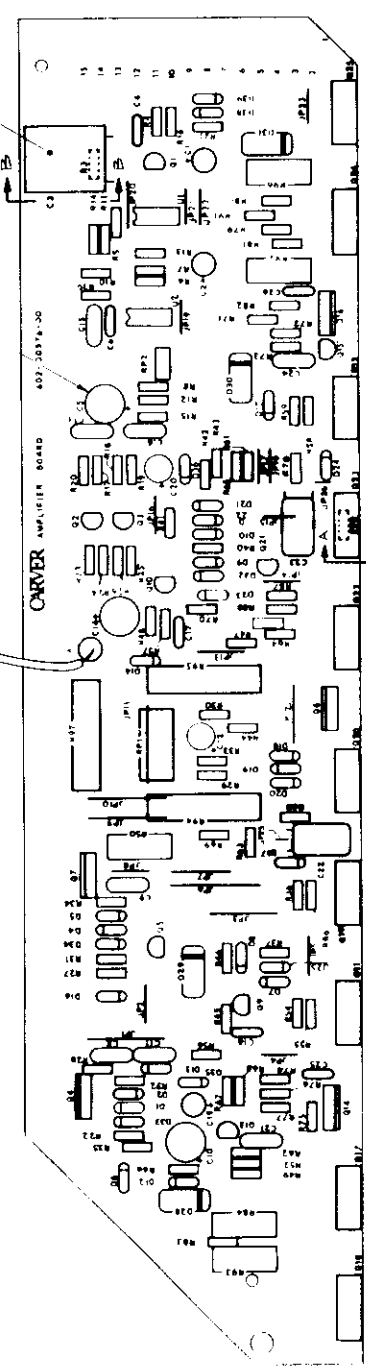
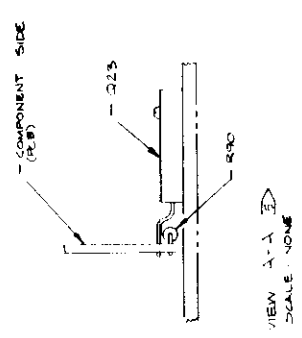
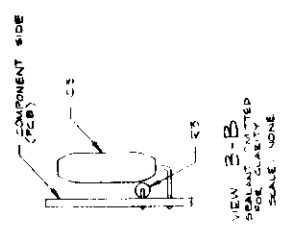

- NOTES - UNLESS OTHERWISE SPECIFIED:
1. ALL PARTS ARE 602-20576-00 UNLESS NOTED
 2. USE PCB TEM-40 REV F
 3. COMPONENT VALUES OF 2.4, 2.7, 10K TO BE MOUNTED PER REV B BY 4 INC
 4. COMPONENTS SHOWN IN DASH LINES ARE TO BE MOUNTED ON COMPONENT SIDE. SEE ITEMS A-A AND B-B.
 5. COMPONENTS SHOWN IN PHANTOM ARE REFERENCE ONLY AS SHALL BE INSTALLED AT FINAL ASSY.
 6. APPLY SEALANT. TEM 1050, UNDER COMPONENT AS REQUIRED.
 7. SHOWN WITHOUT REFERENCE DESIGNATORS AND NOT TO BE INSTALLED.

602-00576-00		1	G
REV	DATE	BY	
1	12-10-81	JLL	
INTEGR. CHANNELS PER ECO # 1319			
CARVER			
ASSY. PCB			
AMPLIFIER			
602-00576-00			
REV 1 OF 1			

FORM NO. 501-00577-00	1	2
DATE	5-12-59	
REVISION		
A	RELEASED PRODUCTION	
B	INCORPORATED EGO # 018	2-2-59
	6-907 500-1	JML

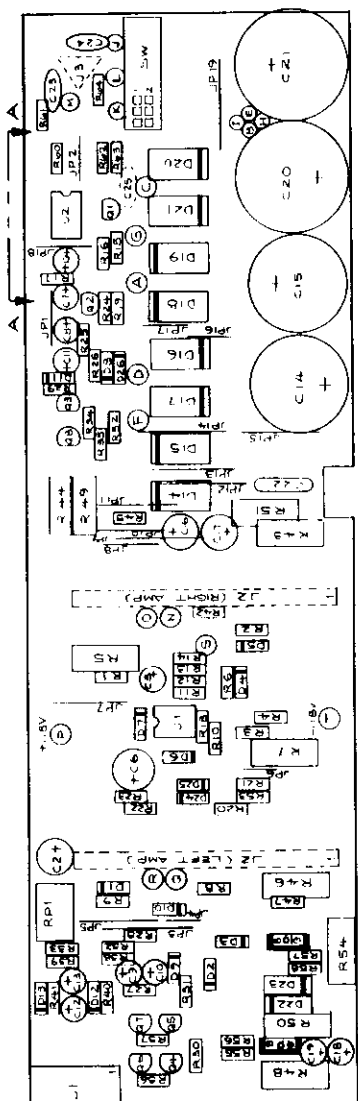
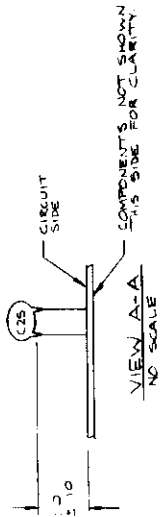

NOTES: UNLESS OTHERWISE SPECIFIED
 1. COMPONENTS DRAWN WITH DASHED
 LINES ARE TO BE MOUNTED ON
 REVERSE SIDE OF BOARD.

DATE	5-12-59	
REVISION		
A	RELEASED PRODUCTION	
B	INCORPORATED EGO # 018	2-2-59
	6-907 500-1	JML

CONTRACT NO.	501-00577-00
DATE	5-12-59
APPROVALS	
DESIGNED BY	W. B. CARVER
CHECKED BY	
DATE	
FORM NO.	501-00577-00
REV.	B
FORM 2-11	
HEET 1 OF 1	

NOTES: UNLESS OTHERWISE SPECIFIED.

1. RESISTANCE IS IN OHMS, 1/4W.
2. DIODES ARE 5R505W.
3. IC1 AND IC2 ARE 4136.

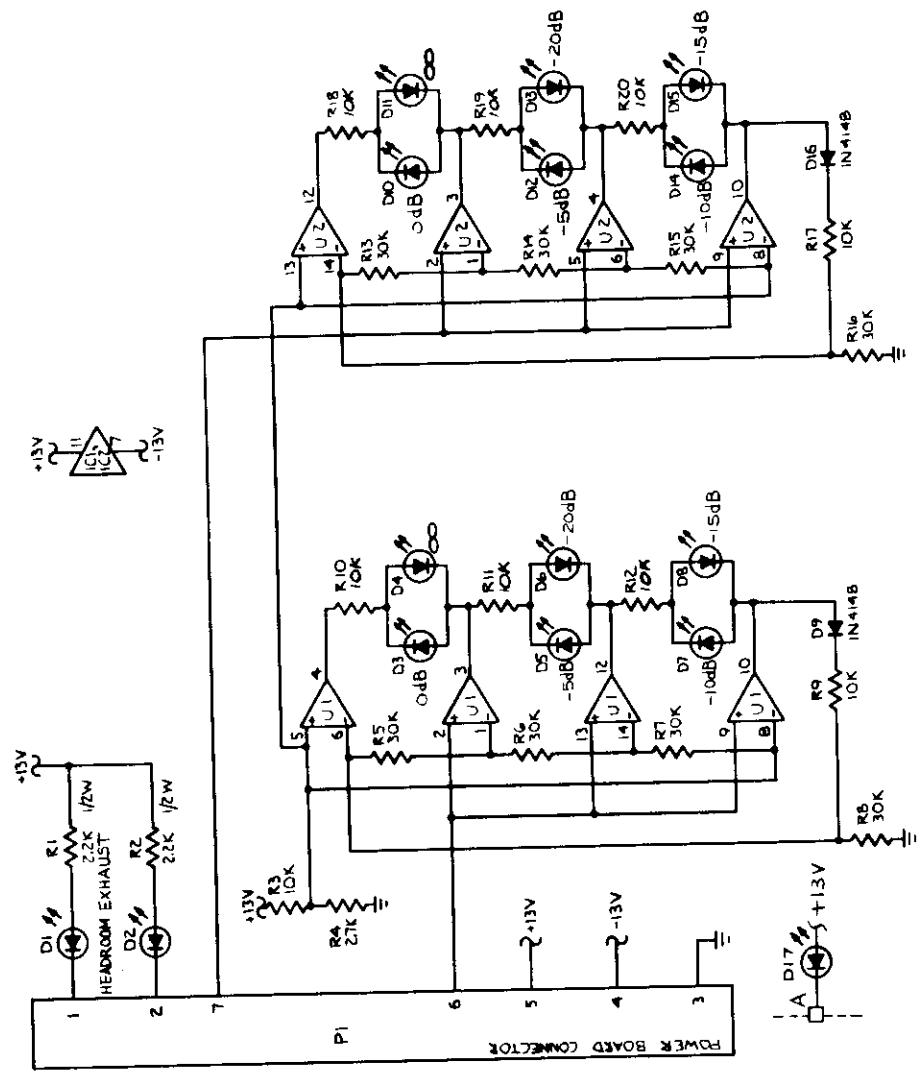

REVISIONS		DATE	APPROVED
ZONE LTR	DESCRIPTION	8-18-78	
A	RELEASED PRODUCTION		

REVISIONS		DATE	APPROVED
ZONE LTR	DESCRIPTION	8-18-78	
A	RELEASED PRODUCTION		

DESIGNER	DATE	APPROVED
PROJECT NO.	REV.	
QUANTITY	SCALE	
DATE	BY	
APPROVED	DATE	
DESIGNER	DATE	
PROJECT NO.	REV.	
QUANTITY	SCALE	
DATE	BY	
APPROVED	DATE	

CARVER CORPORATION
 SCHEMATIC, DISPLAY BD,
 M-4101

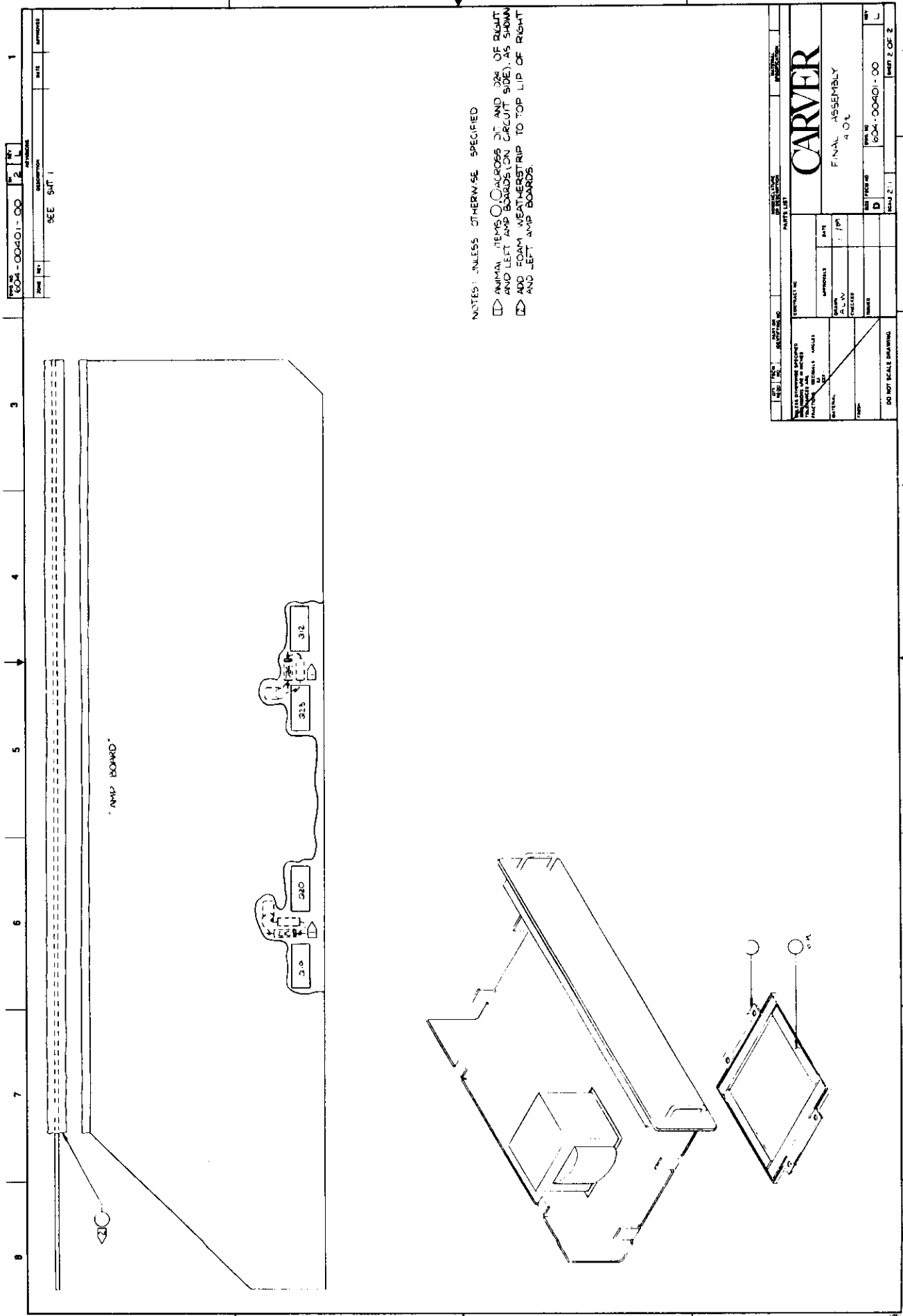

604-00401-00
 PART NO.
 SEE SHIT 1

NOTES: UNLESS OTHERWISE SPECIFIED
 □ ANIMAL ITEMS ○ ACROSS DC AND 224 OF RIGHT AND LEFT AMP BOARDS (ON CIRCUIT SIDE), AS SHOWN
 ▨ ADD FOAM WEATHERSTRIP TO TOP LIP OF RIGHT AND LEFT AMP BOARDS

CARVER FINAL ASSEMBLY 4 0 4	
CONTRACT NO. ORDER NO. PARTS LIST	PART NO. 604-00401-00 REV. L
APPROVALS DATE CHECKED BY FACILE SHEET	SHEET 2 OF 2
DO NOT SCALE DRAWING	

FORM NO. 605-00562-00 1 E

REV.	DATE	DESCRIPTION	BY	APPROVED
A	1-3-60	RELEASE TO PRODUCTIONS	WJW	WJW
B	7-21-60	INCORPORATED ECO #1817	WJW	WJW
C	8-1-60	INCORPORATED ECO #1818	WJW	WJW
D	11-17-60	INCORPORATED ECO #1843	WJW	WJW
E	1-10-61	INCORPORATED ECO #1859	WJW	WJW

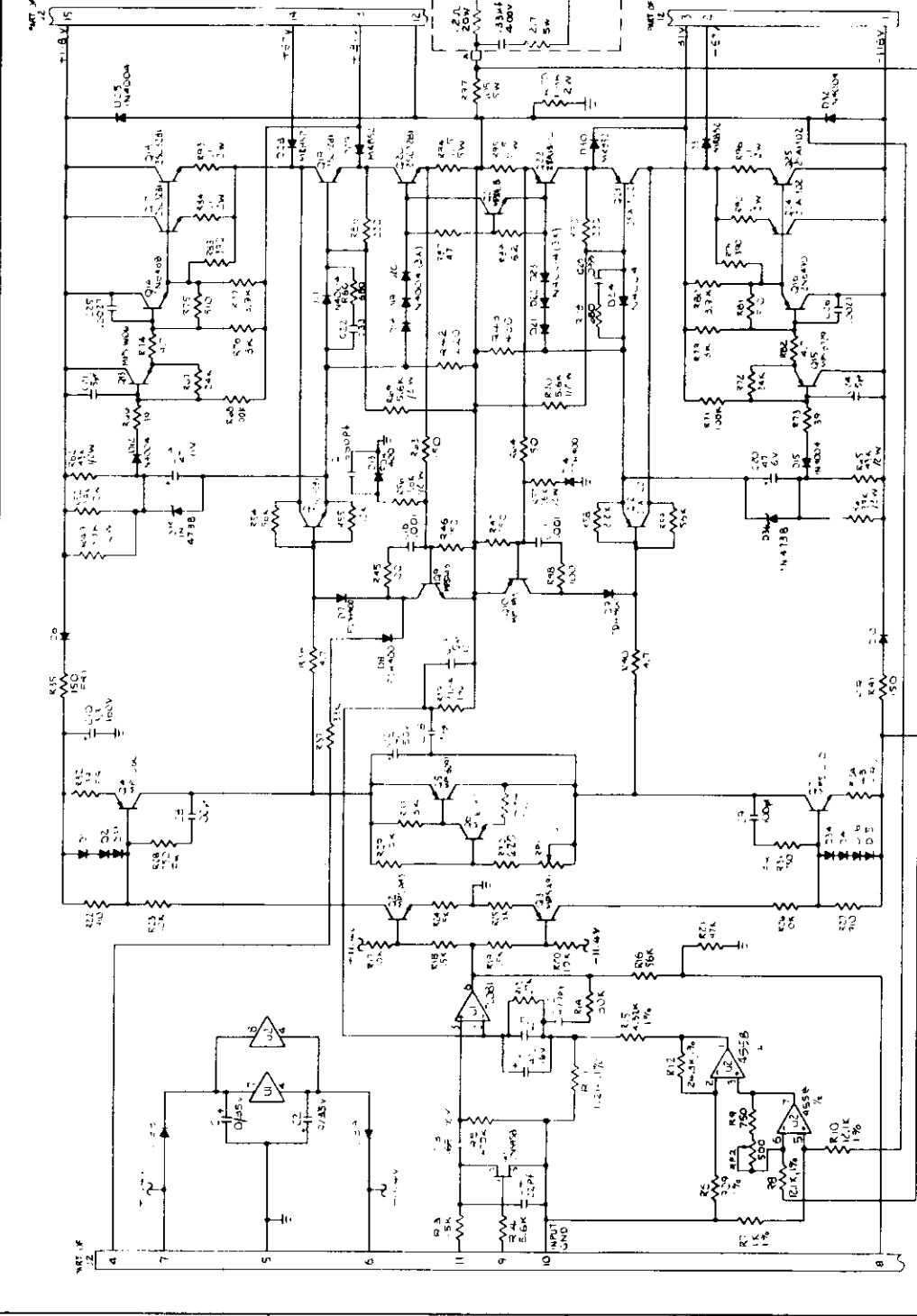

REFERENCE DESIGNATORS

Q1, Q2, Q3, Q4, Q5, Q6, Q7, Q8, Q9, Q10	2N4104
D1, D2	1N4004
F1	1.5A
T1	100V

- 1 ALL DIODES ARE IN4104.
 - 2 ALL CAPACITOR VALUES ARE IN MICROFARADS.
 - 3 ALL RESISTOR VALUES ARE IN OHMS, MM, 1.5K.
- NOTES: VALUES OTHERWISE SPECIFIED

PART LIST

Q1, Q2, Q3, Q4, Q5, Q6, Q7, Q8, Q9, Q10	2N4104	10
D1, D2	1N4004	2
F1	1.5A	1
T1	100V	1

DO NOT SCALE DRAWING

SCALE: 1 OF 1

CARVER
SCHEMATIC,
AMPLIFIER BD

DATE: 1-3-60
DESIGNER: M. J. GIBB
CHECKED: J. E. EDWARDS
DRAWN: J. E. EDWARDS

PROJECT NO. 605-00562-00
REV. 1 OF 1

REV	DESCRIPTION	DATE
1	RELEASED TO PRODUCTION	11/9/70
2	INCORP ECG # 1083	11/11/70
3	INCORP ECG # 431	4/16/70
4	INCORP ECG # 491	5/14/70
5	INCORP ECG # 1534	8/27/70
6	INCORP ECG # 443	11/11/70
7	INCORP ECG # 1653	2/17/71
8	INCORP ECG # 1653	3/19/71

REV	DESCRIPTION	DATE
1	RELEASED TO PRODUCTION	11/9/70
2	INCORP ECG # 1083	11/11/70
3	INCORP ECG # 431	4/16/70
4	INCORP ECG # 491	5/14/70
5	INCORP ECG # 1534	8/27/70
6	INCORP ECG # 443	11/11/70
7	INCORP ECG # 1653	2/17/71
8	INCORP ECG # 1653	3/19/71

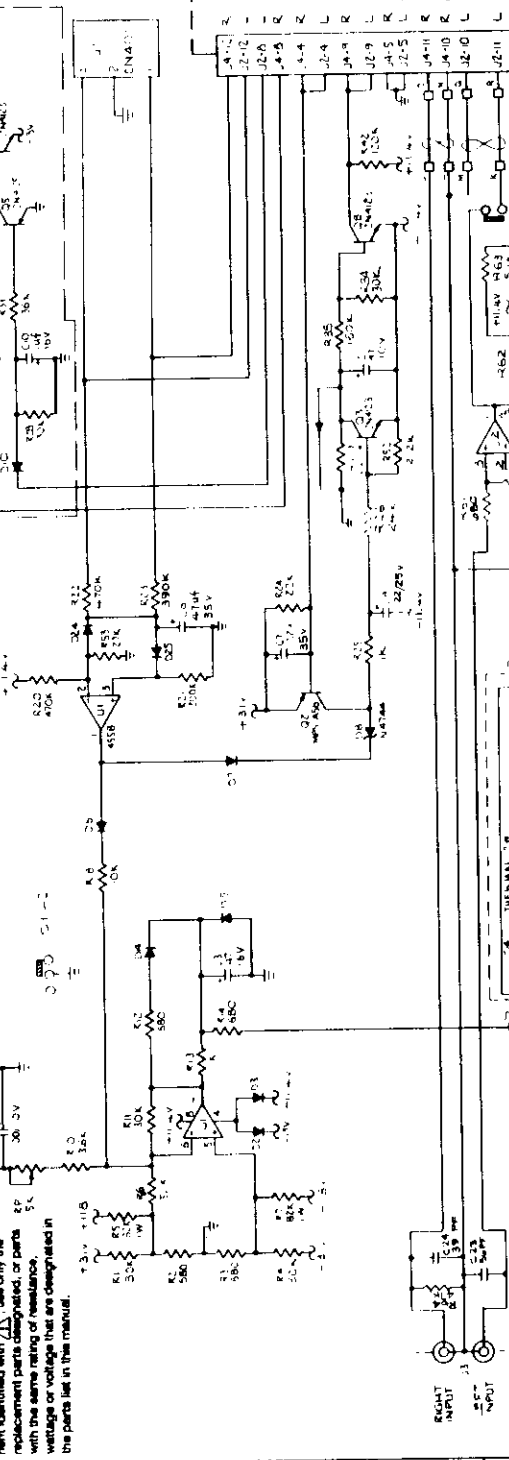
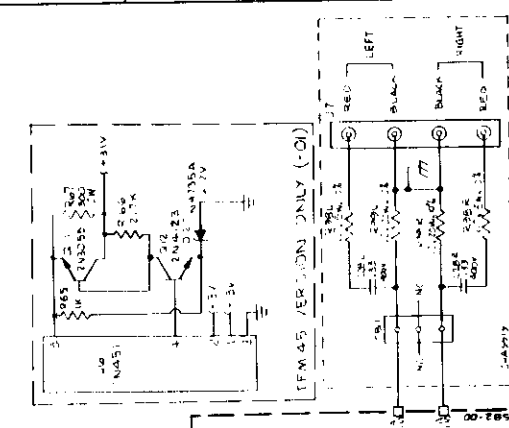

6. REF DESIGNATORS NOT USED: C1, C4, C5, C12, C13, C14, C15, C16, C17, C18, C19, C20, C21, C22, C23, C24, C25, C26, C27, C28, C29, C30, C31, C32, C33, C34, C35, C36, C37, C38, C39, C40, C41, C42, C43, C44, C45, C46, C47, C48, C49, C50, C51, C52, C53, C54, C55, C56, C57, C58, C59, C60, C61, C62, C63, C64, C65, C66, C67, C68, C69, C70, C71, C72, C73, C74, C75, C76, C77, C78, C79, C80, C81, C82, C83, C84, C85, C86, C87, C88, C89, C90, C91, C92, C93, C94, C95, C96, C97, C98, C99, C100.

7. REF DESIGNATORS LAST USED: R1, R2, R3, R4, R5, R6, R7, R8, R9, R10, R11, R12, R13, R14, R15, R16, R17, R18, R19, R20, R21, R22, R23, R24, R25, R26, R27, R28, R29, R30, R31, R32, R33, R34, R35, R36, R37, R38, R39, R40, R41, R42, R43, R44, R45, R46, R47, R48, R49, R50, R51, R52, R53, R54, R55, R56, R57, R58, R59, R60, R61, R62, R63, R64, R65, R66, R67, R68, R69, R70, R71, R72, R73, R74, R75, R76, R77, R78, R79, R80, R81, R82, R83, R84, R85, R86, R87, R88, R89, R90, R91, R92, R93, R94, R95, R96, R97, R98, R99, R100.

1. RESISTORS ARE 1/4W, RESISTANCE 5% UNLESS OTHERWISE SPECIFIED

2. DIODES ARE 1N4148

3. CAPACITANCE IS IN MICRO-FARADS

4. SEE TABULATION TABLE

5. REF DESIGNATORS NOT USED: C1, C4, C5, C12, C13, C14, C15, C16, C17, C18, C19, C20, C21, C22, C23, C24, C25, C26, C27, C28, C29, C30, C31, C32, C33, C34, C35, C36, C37, C38, C39, C40, C41, C42, C43, C44, C45, C46, C47, C48, C49, C50, C51, C52, C53, C54, C55, C56, C57, C58, C59, C60, C61, C62, C63, C64, C65, C66, C67, C68, C69, C70, C71, C72, C73, C74, C75, C76, C77, C78, C79, C80, C81, C82, C83, C84, C85, C86, C87, C88, C89, C90, C91, C92, C93, C94, C95, C96, C97, C98, C99, C100.

7. REF DESIGNATORS LAST USED: R1, R2, R3, R4, R5, R6, R7, R8, R9, R10, R11, R12, R13, R14, R15, R16, R17, R18, R19, R20, R21, R22, R23, R24, R25, R26, R27, R28, R29, R30, R31, R32, R33, R34, R35, R36, R37, R38, R39, R40, R41, R42, R43, R44, R45, R46, R47, R48, R49, R50, R51, R52, R53, R54, R55, R56, R57, R58, R59, R60, R61, R62, R63, R64, R65, R66, R67, R68, R69, R70, R71, R72, R73, R74, R75, R76, R77, R78, R79, R80, R81, R82, R83, R84, R85, R86, R87, R88, R89, R90, R91, R92, R93, R94, R95, R96, R97, R98, R99, R100.

REV	DESCRIPTION	DATE
1	RELEASED TO PRODUCTION	11/9/70
2	INCORP ECG # 1083	11/11/70
3	INCORP ECG # 431	4/16/70
4	INCORP ECG # 491	5/14/70
5	INCORP ECG # 1534	8/27/70
6	INCORP ECG # 443	11/11/70
7	INCORP ECG # 1653	2/17/71
8	INCORP ECG # 1653	3/19/71

CARVER
SCHEMATIC,
POWER SUPPLY

REGULATOR BOARD
405-00560-00

1. RESISTORS ARE 1/4W, RESISTANCE 5% UNLESS OTHERWISE SPECIFIED

2. DIODES ARE 1N4148

3. CAPACITANCE IS IN MICRO-FARADS

4. SEE TABULATION TABLE

5. REF DESIGNATORS NOT USED: C1, C4, C5, C12, C13, C14, C15, C16, C17, C18, C19, C20, C21, C22, C23, C24, C25, C26, C27, C28, C29, C30, C31, C32, C33, C34, C35, C36, C37, C38, C39, C40, C41, C42, C43, C44, C45, C46, C47, C48, C49, C50, C51, C52, C53, C54, C55, C56, C57, C58, C59, C60, C61, C62, C63, C64, C65, C66, C67, C68, C69, C70, C71, C72, C73, C74, C75, C76, C77, C78, C79, C80, C81, C82, C83, C84, C85, C86, C87, C88, C89, C90, C91, C92, C93, C94, C95, C96, C97, C98, C99, C100.

7. REF DESIGNATORS LAST USED: R1, R2, R3, R4, R5, R6, R7, R8, R9, R10, R11, R12, R13, R14, R15, R16, R17, R18, R19, R20, R21, R22, R23, R24, R25, R26, R27, R28, R29, R30, R31, R32, R33, R34, R35, R36, R37, R38, R39, R40, R41, R42, R43, R44, R45, R46, R47, R48, R49, R50, R51, R52, R53, R54, R55, R56, R57, R58, R59, R60, R61, R62, R63, R64, R65, R66, R67, R68, R69, R70, R71, R72, R73, R74, R75, R76, R77, R78, R79, R80, R81, R82, R83, R84, R85, R86, R87, R88, R89, R90, R91, R92, R93, R94, R95, R96, R97, R98, R99, R100.

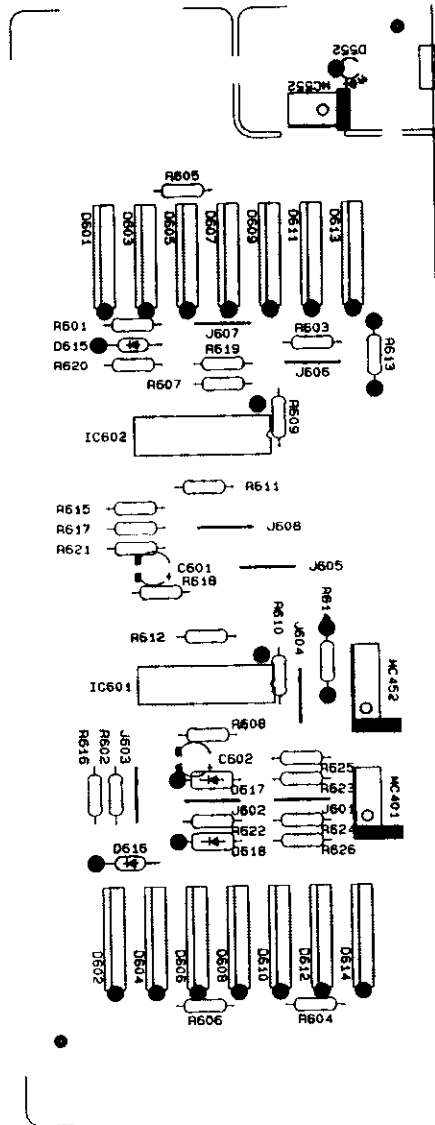

QTY	PART NO.	DESCRIPTION	DATE	BY	APPROVALS	DATE
PARTS LIST						
CONTRACT NO.			DATE			
DRAWN			CHECKED			
REVISION			REMARKS			
MATERIAL			MATERIAL			
DRAWN			DATE			
CHECKED			DATE			
REMARKS			DATE			
SCALE			SCALE			
SHEET NO.			SHEET NO.			
D			LD-813			
OF 1			OF 1			

CARVER

ASSY, PCB
TFM-42 METER BD.

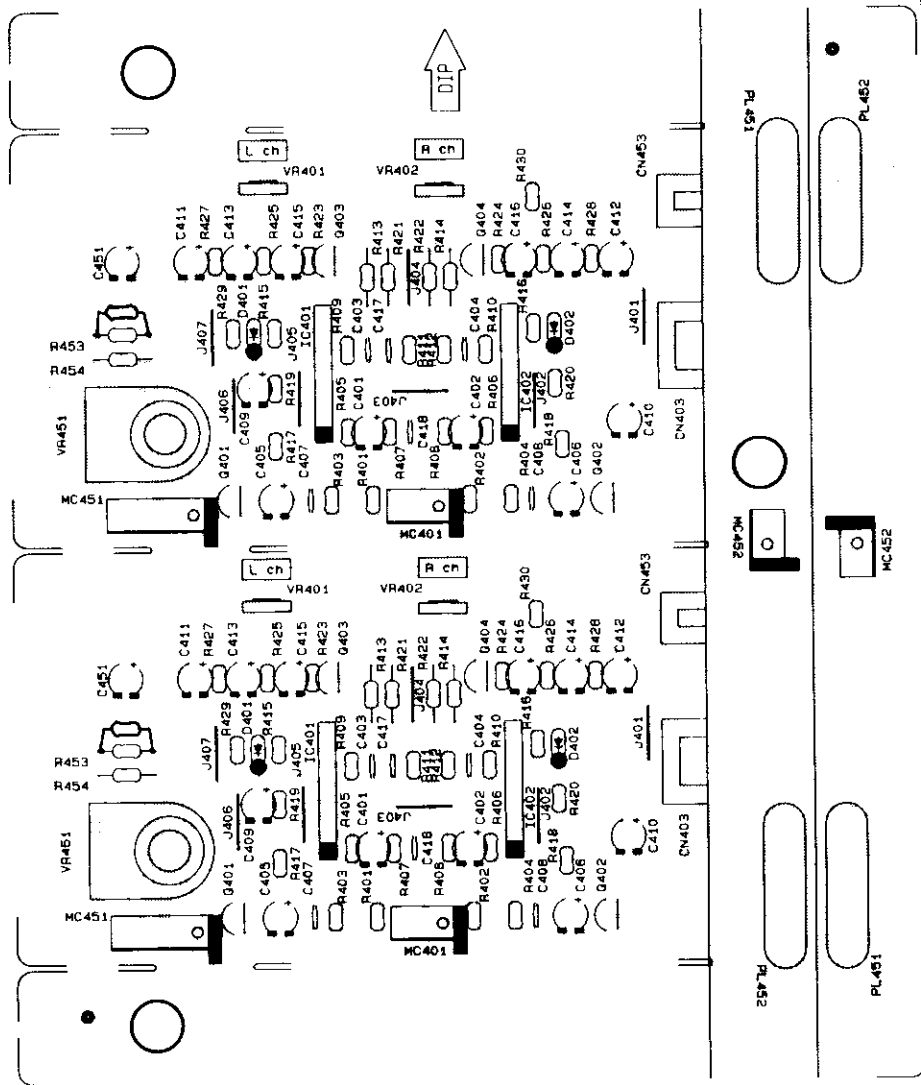

PARTS LIST		DATE	
REV. NO.	REV. DATE	APPROVALS	DATE
DESIGNED BY	DESIGNED DATE	CHECKED BY	CHECKED DATE
DRAWN BY	DRAWN DATE	INSP. BY	INSP. DATE
CONTRACT NO.		PART NO.	
MATERIALS		REV. NO.	
QUANTITY		REV. DATE	
DO NOT SCALE DRAWING		REV. NO.	

CARVER
 ASSY, PCB
 TFM-45 METER BD.

REV. NO. **D** REV. DATE **MD-8/4** PART 1 OF 1

REV	DATE	DESCRIPTION
1		SEE SHEET 1

1 3 4 5 6 7 8

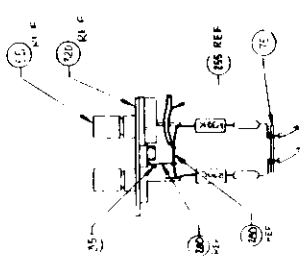
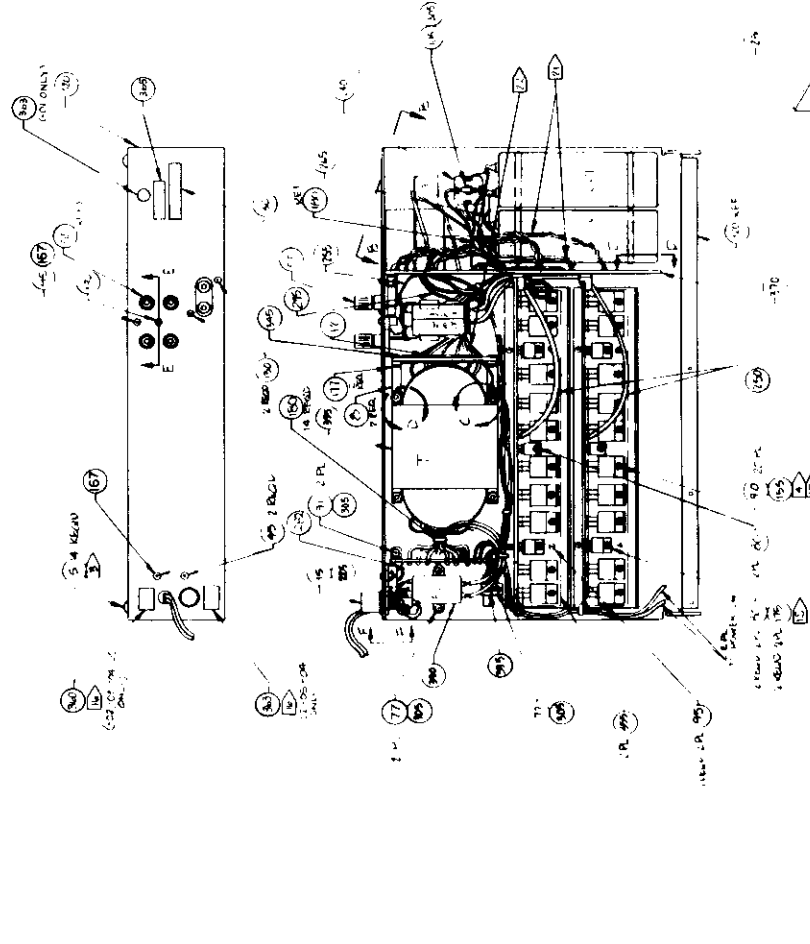
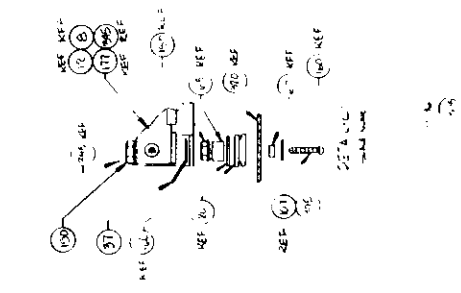
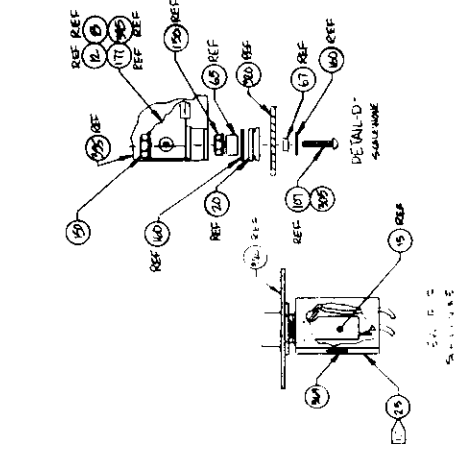

VIEW E-E
SCALE NONE

VIEW D-D
SCALE NONE

SCALE

SCALE

SCALE

SCALE

SCALE

SCALE

SEE SHEET 1 FOR NOTES

<p>CARVER</p> <p>PHILADELPHIA</p> <p>TELEPHONE</p>	
<p>COMPANY</p> <p>ADDRESS</p> <p>CITY</p> <p>STATE</p> <p>COUNTRY</p>	<p>PROJECT</p> <p>DATE</p> <p>SCALE</p> <p>BY</p> <p>CHECKED</p> <p>APPROVED</p>

100-00407-XX

DATE	REV	DESCRIPTION
10-12-65	1	RELEASED TO PRODUCTION
11-9-70	2	INCORP CHANGES PER ESO #347
11-14-70	3	INCORP ESO #1382
11-14-70	4	INCORP ESO #1458
12-7-70	5	INCORP ESO #1458
12-29-70	6	INCORP ESO #1458
1-11-71	7	INCORP ESO #1458
1-11-71	8	INCORP ESO #1458

REAR PANEL AS VIEWED FROM NSIDE CHASSIS

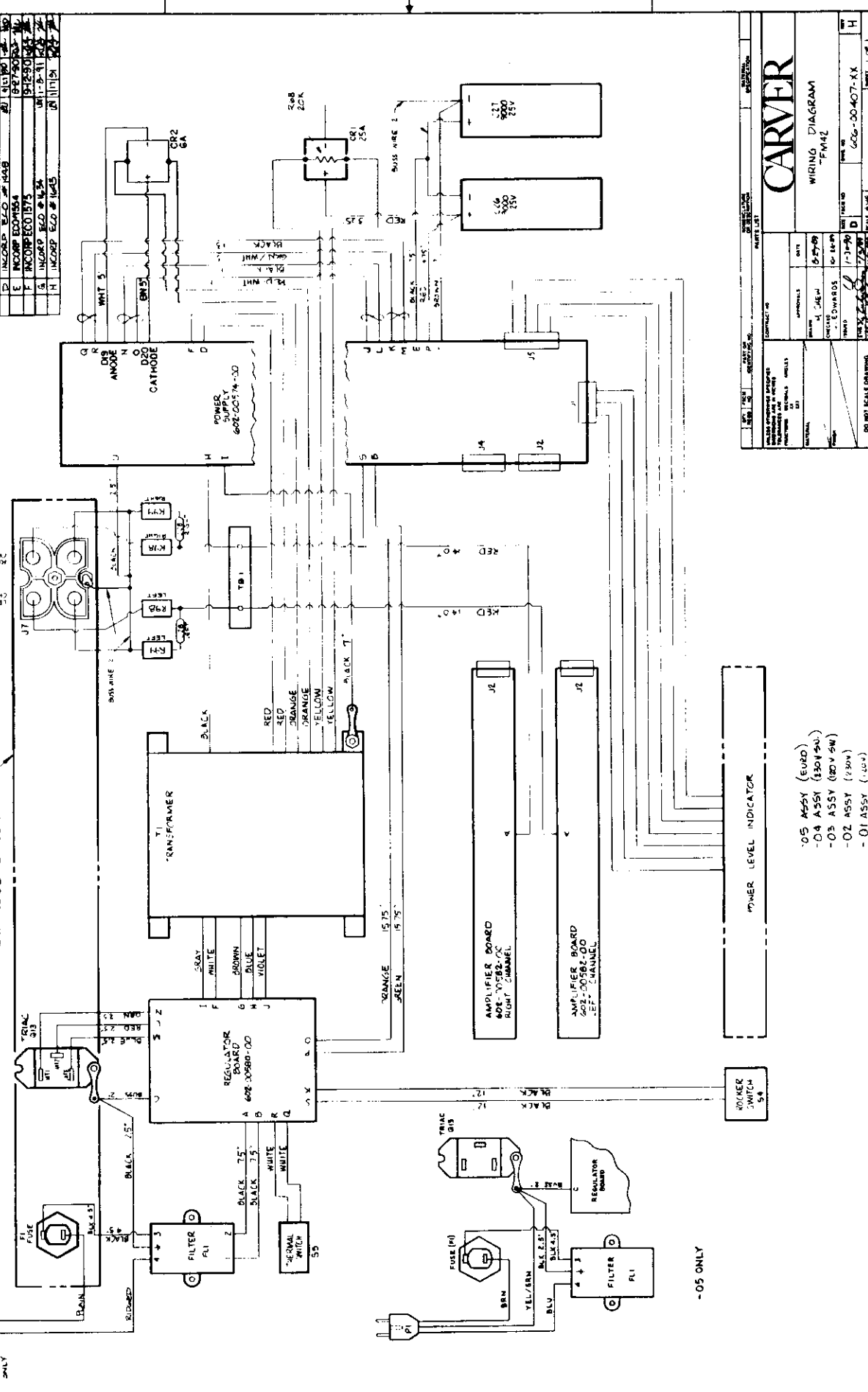

CARVER

WIRING DIAGRAM
"FM42"

DATE: 10-12-65
DRAWN BY: J. J. JONES
CHECKED BY: J. J. JONES
APPROVED BY: J. J. JONES

DO NOT SCALE DRAWING

- 05 ASSY (EVRD)
- 04 ASSY (350V 90L)
- 03 ASSY (180V 5M)
- 02 ASSY (120V)
- 01 ASSY (100V)

-05 ONLY

████████████████████

Section 9

APPENDICES

████████████████████

Appendix A

PARTS ORDERING

Please provide the Model numbers of the units involved when ordering genuine CARVER replacement parts. Also provide the CARVER part number and the generic part number to confirm the correct part needed.

The Carver Parts Department is open Monday thru Friday, 7:00 a.m. to 4:45 p.m. PST.
The following phone number is to be used for part orders only!
Technical assistance is not available on this line.

1-800-433-0547

Or if you prefer to FAX in your part order, please use the following FAX number:

1-206-775-9180

From time to time, when it is necessary, we may make a substitution for the original part ordered, due to circuit revisions or part availability.

Random deviation from the original CARVER designated part is not recommended!

Complete PCB replacement is not recommended. You must have prior approval for warranty repair should PCB replacement be necessary.

Appendix B PARTS LISTS

**M4.01/TFM-4.0 AMP BOARD
P/N 602-00576-00**

CAPACITORS

CARVER P/N	DESCRIPTION	REF DESIGNATORS	NOTES
201-00001-00	CAP CER DISC 5pF 10% 1000V	C21,24	
201-00004-00	CAP CER DISC 22pF 10% 1000V	C4	*Rev.B
201-00006-00	CAP CER DISC 39pf 10% 1000V	C18	
201-00012-00	CAP CER DISC 100pf 10% 1000V	C8,9	
201-00016-00	CAP CER DISC 180pF 10% 1000V	C7	Delete at Rev.E
201-00023-00	CAP CER DISC 470pF 10% 1000V	C15	*Rev.B
201-00026-00	CAP CER DISC 680pf 10% 1000V	C11	
201-00040-00	CAP CER DISC 15pF 10% 1000V	C13	
204-00003-00	CAP MYLAR .001μF	C16,17	
204-00008-00	CAP MYLAR .0027μF	C24,26	
204-00015-00	CAP MYLAR .01μF	C6	
204-00022-00	CAP MYLAR .033μF 10%	C22,23	Add at Rev.B
204-00052-00	CAP MYLAR .68μF 100V	C3	
205-00006-00	CAP LYTIC 4.7μF 50V RAD	C12	
205-00010-00	CAP LYTIC 10μF 35V RAD	C1,2	
205-00013-00	CAP LYTIC 47μF 16V RAD	C19,20	
205-00020-00	CAP LYTIC 470μF 10V RD BLU TWK	C5	
205-00078-00	CAP LYTIC 3.3 μF 160V	C10,14	
*HISTORY			
201-00009-00	CAP CER DISC 68pF 10% 1000V	C4	Rev.A
201-00022-00	CAP CER DISC 390pF 10% 1000V	C15	Rev.A

RESISTORS

CARVER P/N	DESCRIPTION	REF DESIGNATORS	NOTES
250-00003-00	RES FL RTD 39 OHM 1/4W PREP .4	R32	
250-00005-00	RES FL RTD 150 OHM 1/4W PREP .4	R35,41	
250-00007-00	RES FL RTD 750 OHM 1/4W PREP .4	R28,31	
250-00008-00	RES FL RTD 43 OHM 1/4W PREP .4	R34	

CARVER P/N	DESCRIPTION	REF DESIGNATORS	NOTES
251-00014-00	RES CFILM 4.7 OHM 1/4W PREP .4	R36,40,74,82	
251-00036-00	RES CFILM 39 OHM 1/4W PREP .4	R66,73	
251-00038-00	RES CFILM 47 OHM 1/4W PREP .4	R87	*Rev.J Parts List
251-00041-00	RES CFILM 62 OHM 1/4W PREP .4	R88	
251-00046-00	RES CFILM 100 OHM 1/4W PREP .4	R45,48	
251-00050-00	RES CFILM 150 OHM 1/4W PREP .4	R63,64	
251-00054-00	RES CFILM 220 OHM 1/4W PREP .4	R42,86,90	
251-00060-00	RES CFILM 390 OHM 1/4W PREP .4	R83,91	
251-00061-00	RES CFILM 430 OHM 1/4W PREP .4	R43	
251-00063-00	RES CFILM 510 OHM 1/4W PREP .4	R75,81	
251-00065-00	RES CFILM 620 OHM 1/4W PREP .4	R44,30	*Rev.J Parts List
251-00066-00	RES CFILM 680 OHM 1/4W PREP .4	R60,78	Add at Rev.B
251-00067-00	RES CFILM 750 OHM 1/4W PREP .4	R46,47	
251-00074-00	RES CFILM 1.5 K 1/4W PREP .4	R18,19,24,25	
251-00078-00	RES CFILM 2.2 K 1/4W PREP .4	R55,58	
251-00081-00	RES CFILM 3 K 1/4W PREP .4	R33,76,79	
251-00084-00	RES CFILM 3.9 K 1/4W PREP .4	R77,80	
251-00088-00	RES CFILM 5.6 K 1/4W PREP .4	R4	
251-00094-00	RES CFILM 10 K 1/4W PREP .4	R17,20,23,26,29	
251-00098-00	RES CFILM 15 K 1/4W PREP .4	R3	
251-00103-00	RES CFILM 24 K 1/4W PREP .4	R67,72	
251-00104-00	RES CFILM 27 K 1/4W PREP .4	R13	
251-00105-00	RES CFILM 30 K 1/4W PREP .4	R14	
251-00106-00	RES CFILM 33 K 1/4W PREP .4	R37	
251-00110-00	RES CFILM 47 K 1/4W PREP .4	R21	
251-00112-00	RES CFILM 56 K 1/4W PREP .4	R16,54,59	
251-00118-00	RES CFILM 100 K 1/4W PREP .4	R68,71	
251-00134-00	RES CFILM 470 K 1/4W PREP .4	R5	*Rev.B
251-10083-00	RES CFILM 3.6 K 1/2W PREP .5	R56,57	
251-10089-00	RES CFILM 5.6K 1/2W PREP .5	R69,70	
251-10108-00	RES CFILM 39 K 1/2W PREP .5	R49,52,61	
251-10109-00	RES CFILM 43 K 1/2W PREP .5	R62,65	
252-00285-00	RES MFILM 909 OHM 1/4W 1% .4	R6	
252-00355-00	RES MFILM 1K 1/4W 1% .4	R7	
252-00356-00	RES MFILM 1.21 K 1/4W 1% .4	R11	*Rev.B
252-00367-00	RES MFILM 4.32 K 1/4W 1% .4	R15	*Rev.B
252-00385-00	RES MFILM 12.1 K 1/4W 1% .4	R8,10	
252-00420-00	RES MFILM 24.3 K 1W 1% .4		
252-00427-00	RES MFILM 31.6 K 1/4W 1% .4	R39	
253-20001-00	RES WIRE WOUND .1 OHM 2W		
253-40000-00	RES WIRE WOUND .05 OHM 5W 10%	R94,95,97	
255-20108-00	RES MET OXIDE 1.8 K 2W		
259 20001 00	TRIM POT 1 K 1/10W PCB MT	RP1	*Rev.J Parts List
259 20010 00	TRIM POT 2 K 1/10W PCB MT	RP2	Add at Rev.F

CARVER P/N	DESCRIPTION	REF DESIGNATORS	NOTES
*HISTORY			
251-00040-00	RES CFILM 56 OHM 1/4W PREP .4	R87	Rev.A-H Parts List
251-00065-00	RES CFILM 620 OHM 1/4W PREP .4	R44	Rev.A-E1
251-00069-00	RES CFILM 910 OHM 1/4W PREP .4	R30	Rev.A-D Parts List
251-00071-00	RES CFILM 1.1 K 1/4W PREP .4	R30	Rev.E-G Parts List
251-00070-00	RES CFILM 1.0 K 1/4W PREP .4	R30	Rev.H Parts List
251-00070-00	RES CFILM 1.0 K 1/4W PREP .4	R9	Rev.A-F, Delete during Rev.F
251-00118-00	RES CFILM 100 K 1/4W PREP .4	R5	Rev.A
252-00355-00	RES CFILM 1.0 K 1/4W 1% .4	R11	Rev.A
252-00414-00	RES CFILM 20.0 K 1/4W 1% .4	R15	Rev.A
259-20001-00	TRIM POT 1 K PCB MT	RP1	Rev.A-D Parts List
259-30000-00	TRIM POT 300 OHM or 250 OHM PCB MT	RP1	Rev.E-H Parts List

DIODES

CARVER P/N	DESCRIPTION	REF DESIGNATORS	NOTES
320-20001-00	DIODE 1N4148 75V PREP .4	D1,2,4-6,10,16,33,34,38,39	
320-20004-00	DIODE 1N4004 400V PREP .4	D12,15,18-25,32	
320-20006-00	DIODE FDH 400 400V PREP .4	D7,8,9,13,14	
320-20007-03	DIODE MR 852 UNPREP	D28-31	
320-30006-00	DIODE ZENER 1N4738 8.2V PREP .4	D35,36	

TRANSISTORS

CARVER P/N	DESCRIPTION	REF DESIGNATORS	NOTES
321-10000-00	XISTOR 152 NPN SM SG MPS W06	Q13	*Rev.F Parts List
321-10001-00	XISTOR 152 PNP SM SG MPS 6729	Q15	*Rev.F Parts List
321-20001-00	XISTOR 202 NPN POW MPS U10	Q7	
321-20002-00	XISTOR 202 PNP POW MPS U60	Q4	
321-30013-00	XISTOR T03P(L) NPN PWR 29C3281	Q11,17,18,19,20	
321-30014-00	XISTOR T03P(L) PNP PWR 2SA1302	Q12,22,23,24,25	
321-40000-00	XISTOR T092 NPN SM SG MPS 8097	Q21	
321-40001-00	XISTOR T092 NPN SM SG MPS A43	Q2,9	*Rev.F Parts List
321-40003-00	XISTOR T092 MPS 8093(SUB FPN4)	Q6	
321-40004-00	XISTOR T092 PNP SM SG MPS A93	Q3,10	*Rev.F Parts List
321-40005-00	XISTOR T092 JFET SM SG 2N 5458	Q1	
321-60004-00	XISTOR T0220 NPN 2N6488	Q14	
321-60006-00	XISTOR T0220 PNP 2N6490	Q16	
321-60007-00	XISTOR T0225AA NPN PWR MJE 180	Q6	
*HISTORY			
321-10000-00	XISTOR 152 NPN SM SG MPS W06	Q13,9	Rev.A-E Parts List
321-10001-00	XISTOR 152 PNP SM SG MPS U10	Q15,10	Rev.A-E Parts List
321-40001-00	XISTOR T092 NPN SM SG MPS A43	Q2	Rev.A-E Parts List
321-40004-00	XISTOR T092 PNP SM SG MPS A93	Q3	Rev.A-E Parts List

INTEGRATED CIRCUITS



CARVER P/N	DESCRIPTION	REF DESIGNATORS	NOTES
330-30002-00	IC OP AMP BIFET (TL081)	U1	
330-30008-00	IC DUAL OP AMP (4558)	U2	

MISCELLANEOUS ITEMS

CARVER P/N	DESCRIPTION	REF DESIGNATORS	NOTES
160-30012-00	HEADER 15 PIN 800G	P2	
401-20203-00	BUSS WIRE 22 GAGE		USE WITH RP2
401-30003-00	JUMPER INSULATED .4"	JP2-5,14,16-22	
401-30005-00	JUMPER INSULATED .5"	JP7,13,20	
401-30006-00	JUMPER INSULATED .6"	JP6,12	
401-30013-00	JUMPER INSULATED .8"	JP1,6,9,10,11	
403-10003-00	SEALANT SILICONE RUBBER RTV		
501-00576-00	PCB, AMP M-4.0t		

M4.0t/TFM-4.0 POWER SUPPLY BOARD P/N 602-00577-00

CAPACITORS

CARVER P/N	DESCRIPTION	REF DESIGNATORS	NOTES
201-00006-00	CAP CER DISC 39pF 10% 1000V	C24	Add at Rev.B
201-00034-00	CAP CER DISC .01μF 20 % 500V	C22	
201-00041-00	CAP CER DISC 56pF 10% 1000V	C23	Add at Rev.B
205-00002-00	CAP LYTIC 2.2μF 35V RAD	C7	
205-00011-00	CAP LYTIC 22μF 16V RAD	C18,19	
205-00013-00	CAP LYTIC 47μF 25V RAD	C3,4,16,17	
205-00014-00	CAP LYTIC 47μF 50V RAD	C6	
205-00015-00	CAP LYTIC 100μF 10V RAD	C2	
205-00034-00	CAP LYTIC 47μF 10V 20% RAD	C11	
205-00041-00	CAP LYTIC 22μF 5V 20% RAD	C8	
205-00053-00	CAP LYTIC 1μF 16V 10% RAD	C9,10,12,13	
205-00079-00	CAP 3300 μF 35V RAD	C14,15	
205-00080-00	CAP LYTIC 200μF 80V RAD	C20,21	

RESISTORS

CARVER P/N	DESCRIPTION	REF DESIGNATORS	NOTES
250-00004-00	RES FL RTD 82 OHM 1/4 W .4	R57	
250-00006-00	RES FL RTD 270 OHM 1/4W .4	R55	
251-00066 (K)	RES CFILM 680 OHM 1/4W PREP .4	R2,3,12,14,15,61	*Rev.E Parts List
251-00067-00	RES CFILM 750 OHM 1/4W PREP .4	R8	
251-00070-00	RES CFILM 1 K 1/4W PREP .4	R13,19,25	

CARVER P/N	DESCRIPTION	REF DESIGNATORS	NOTES
251-00075-00	RES CFILM 1.6 K 1/4W PREP .4	R38,39	
251-00082-00	RES CFILM 3.3 K 1/4 W PREP .4	R8	
251-00083-00	RES CFILM 3.6 K 1/4 W PREP .4	R10	
251-00087-00	RES CFILM 5.1 K 1/4W PREP .4	R8,56,58,62,63	
251-00094-00	RES CFILM 10 K 1/4W PREP .4	R18	
251-00095-00	RES CFILM 11 K 1/4W PREP .4	R32,33	
251-00102-00	RES CFILM 22 K 1/4W PREP .4	R24	
251-00103-00	RES CFILM 24 K 1/4W PREP .4	R26	
251-00104-00	RES CFILM 27 K 1/4W PREP .4	R53	
251-00105-00	RES CFILM 30 K 1/4W PREP .4	R11,35	
251-00107-00	RES CFILM 36 K 1/4W PREP .4	R30,31,36,37	
251-00114-00	RES CFILM 68 K 1/4W PREP .4	R16	*Rev.B
251-00118-00	RES CFILM 100 K 1/4W PREP .4	R60,R64	*Rev.E Parts List
251-00120-00	RES CFILM 120 K 1/4W PREP .4	R42	*Rev.B
251-00121-00	RES CFILM 130 K 1/4W PREP .4	R1,4,27,28,40,41	
251-00122-00	RES CFILM 150 K 1/4W PREP .4	R34	
251-00125-00	RES CFILM 200 K 1/4W PREP .4	R21	
251-00126-00	RES CFILM 220 K 1/4W PREP .4	R29	
251-00128-00	RES CFILM 270 K 1/4W PREP .4	R17	*Rev.B
251-00132-00	RES CFILM 390 K 1/4W PREP .4	R23	
251-10080-00	RES CFILM 2.7 K 1/4W PREP .4	R45,47	
255-10115-00	RES MET OXIDE 1.3 K 1W	R48	
255-10116-00	RES MET OXIDE 1.1 K 1W	R50	
255-10120-00	RES MET OXIDE 9.1 K 1W	R54	*Rev.F Parts List
255-10133-00	RES MET OXIDE 15 K 1W	R49	*Rev.F Parts List
255-10136-00	RES MET OXIDE 18 K 1W	R46	
255-10137-00	RES MET OXIDE 20 K 1W	R44	
255-10150-00	RES MET OXIDE 82 K 1W	R5,7	
255-20095-00	RES MET OXIDE 680 OHM 2W	R43,51	
259-20003-00	TRIM POT 5K PCB MOUNT	RP1	
*HISTORY			
251-00066-00	RES CFILM 680 OHM 1/4W PREP .4	R2,3,12,14,15	Rev.A
251-00078-00	RES CFILM 2.2 K 1/4W PREP .4	R61	Rev.A-D Parts List
251-00118-00	RES CFILM 100 K 1/4W PREP .4	R60,64	Rev.A
251-00118-00	RES CFILM 100 K 1/4W PREP .4	R64	Rev.B-D Parts List
251-00120-00	RES CFILM 120 K 1/4W PREP .4	R16,42	Rev.A
251-00135-00	RES CFILM 510 K 1/4W PREP .4	R17	Rev.A
251-00134-00	RES CFILM 470 K 1/4W PREP .4	R60	Rev.B-D Parts List
255-10133-00	RES MET OXIDE 15 K 1W	R49,R54	Rev.A-E Parts List

DIODES

CARVER P/N	DESCRIPTION	REF DESIGNATORS	NOTES
320-20001-00	DIODE 1N4148 75V PREP	D2-7,9-11,24-26	
320-20004-00	DIODE 1N4004 400V PREP .4	D12,13	
320-20010-03	DIODE 6 AMP 200V UNPREP	D14-21	!
320-30002-00	DIODE ZENER 1N4744 15V PREP .4	D8	
320-30008-00	DIODE ZENER 1N4735 6.2V PREP .4	D1	
320-30012-00	DIODE ZENER 1N4742 12V PREP .6	D22,23	

TRANSISTORS

CARVER P/N	DESCRIPTION	REF DESIGNATORS	NOTES
321-40000-00	XISTOR T092 NPN SM SG MP3 8087	Q1	
321-40009-00	XISTOR T092 PNP SM SG 2N4125	Q4,5	
321-40010-00	XISTOR T092 NPN SM SG 2N4123	Q3,6,7,8	
321-40012-00	XISTOR T092 PNP SM SG MP5A56	Q2	
321-90000-00	XISTOR B100 PNP PWR 2SA1360	Q10	
321-90001-00	XISTOR B100 NPN PWR 2SC3423	Q9	

INTEGRATED CIRCUITS

CARVER P/N	DESCRIPTION	REF DESIGNATORS	NOTES
330-30008-00	IC DUAL OP AMP 4558	U1,2	

MISCELLANEOUS ITEMS

CARVER P/N	DESCRIPTION	REF DESIGNATORS	NOTES
109-10006-00	PHONO JACK DUAL PC MOUNT	J3	
159-20002-00	POP RIVET AL DE 1/8" .063-.125" GRIP		
160-20002-00	CONNECT 7 PIN GOLD	J1	
201-00006-00	CAP CER DISC 39pF 10% 1000V	J1	
201-00041-00	CAP CER DISC 56pF	C23	
251-00066-03	RES CFILM 690 OHM 1/4W UNPREP	R61	
251-00118-03	RES CFILM 100K 1/4W UNPREP	R60,64	
318-10009-00	SWITCH PUSH 1KEY NO FRAME MINI		
401-10117-01	WIRE 18 AWG TR-64 BROWN 7'	WP-9	
401-10168-00	WIRE 18 AWG TEW VIOLET 4.75'	WP-5	
401-10580-00	WIRE 22 AWG TR-64 ORANGE 15.75'	WP-8	
401-10629-00	WIRE 22 AWG TR-64 ORANGE 2.0'	C-26	
401-30002-00	JUMPER INSUL .3"	JP4,6,19	
401-30003-00	JUMPER INSUL .4"	JP16,17,22	
401-30005-00	JUMPER INSUL .5"	JP8,18,20	
401-30006-00	JUMPER INSUL .6"	JP1,2,10	
401-30007-00	JUMPER INSUL .7"	JP5,7,11	
401-30013-00	JUMPER INSUL .8"	JP3,9,12,13,14,15,21	
401 40006-00	WIRE T #22 1EA RED/AWH,BLK 13"		BLK WP-N TO WP-L; RED/AWH WP-0 TO WP-J
401-40008-00	WIRE T #22 1EA GRN/AWH,BLK 9"		BLK WP-Q TO WP-M; GRN/AWH WP-R TO WP-K
501-00577-00	PCB POWER SUPPLY M-4.0I		
507-00003-00	BRACKET, MOLEX CON SUPPORT 90 DG		

M4.0t/TFM-4.0 REGULATOR BOARD P/N 602-00578-00

CAPACITORS

CARVER P/N	DESCRIPTION	REF DESIGNATORS	NOTES
204-00015-00	CAP MYLAR .01 μ F	C3	
204-00031-00	CAP MYLAR .33 μ F	C4	
207-10010-00	CAP MET POLY .1 μ F/250V Rad.	C5	



RESISTORS

CARVER P/N	DESCRIPTION	REF DESIGNATORS	NOTES
251-00014-00	RES CFILM 4.7OHM 1/4W PREP .4	R10	
251-00030-00	RES CFILM 22 OHM 1/4W PREP .4	R5	
251-00088-00	RES CFILM 15K 1/4W PREP .4	R3	
251-00100-00	RES CFILM 18K 1/4W PREP .4	R9	
251-00118-00	RES CFILM 100K 1/4W PREP .4	R6,7	
251-00124-00	RES CFILM 180K 1/4W PREP .4	R8	
251-00135-00	RES CFILM 510K 1/4W PREP .4	R4	
251-10022-00	RES CFILM 10 OHM 1/2W PREP .5	R11	
251-10109-00	RES CFILM 43K 1/2W PREP .5	R2	
251-10156-00	RES CFILM 3.9M 1/2W PREP .5	R1	

DIODES

CARVER P/N	DESCRIPTION	REF DESIGNATORS	NOTES
320-20004-00	DIODE 1N4004 400V PREP .4	D1-6	

TRANSISTORS

CARVER P/N	DESCRIPTION	REF DESIGNATORS	NOTES
321-40011-00	XISTOR T092 NPN SM SG MPSA06	Q1,3	
321-40012-00	XISTOR T092 PNP SM SG MPSA56	Q2,4	

INTEGRATED CIRCUITS

CARVER P/N	DESCRIPTION	REF DESIGNATORS	NOTES
330-40002-00	OPTOISOLATOR PHOTOCOUPLER	U1	

MISCELLANEOUS ITEMS

CARVER P/N	DESCRIPTION	REF DESIGNATORS	NOTES
101-22001-00	BRACKET RECTANGLE PCB MNT 1/2		
159-20001-00	POP RIVET GE 1/8"		
318-00002-00	SWITCH CONV 115/223 1A 125 VAC		
401-10142-00	WIRE 18 AWG TEW BLK 7.5'	WP-B, WP-A	
401-10572-00	WIRE 22 AWG TEW BLUE 10'	WP-D, WP-E	
401-10581-00	WIRE 22 AWG TR-64 GREEN 15.75'	WP-P	
501-00578-00	PCB REGULATOR M-4.0T		

M4.0t/TFM-4.0 DISPLAY BOARD
P/N 602-00579-00

RESISTORS

CARVER P/N	DESCRIPTION	REF DESIGNATORS	NOTES
251-00080-00	RES CFILM 2.7K 1/4W PREP .4	R4	
251-00094-00	RES CFILM 10K 1/4W PREP .4	R3,9-12,17-20	
251-00105-00	RES CFILM 30K 1/4W PREP .4	R5-8,13-16	
251-10078-00	RES CFILM 2.2K 1/2W PREP .5	R1,2	

DIODES

CARVER P/N	DESCRIPTION	REF DESIGNATORS	NOTES
320-20001-00	DIODE 1N4148 75V PREP .4	D9,16	
320-40001-00	LED RED	D3-8,10-15	
320-40002-00	LED AMBER	D1,2,17	

INTEGRATED CIRCUITS

CARVER P/N	DESCRIPTION	REF DESIGNATORS	NOTES
330-30003-00	IC QUAD OP AMP 4136	IC1,2	



MISCELLANEOUS ITEMS

CARVER P/N	DESCRIPTION	REF DESIGNATORS	NOTES
401-30003-00	JUMPER INSUL .4	JP1-B	
160-30004-00	HEADER 7 PIN GOLD .7	P1	
401-10610-00	WIRE 22 AWG TR-64 VIOLET 11.5"	WP-A	
501-00579-00	PCB DISPLAY M4.0T		

M4.0t/TFM-4.0 FINAL ASSEMBLY
P/N 607-00401-00



CARVER P/N	ITEM NO.	DESCRIPTION	REF DESIGNATORS	NOTES
101-30001-00	5	BUMPS RUBBER ROUND MED		
105-40006-00	15	FUSEHOLDER PANEL MNT 120V/240V		
106-30002-00	20	GROMMET, GUM		X-fmr Mt. 1Rev.F
108-00102-00	25	INSULATOR, RAG PAPER .015"		
111-00002-00	30	LABEL, MONSTER CABLE		
111-20051-00	35	SOLDER LUG #6		Add at Rev.K
111-20151-00	40	SOLDER LUG #10		
112-20002-00	45	MOUNT, SNAKE LUG		Add at Rev.K
112-20003-00	50	MOUNT TYRAP, SCREW MNT		
115-30007-00	55	BINDING POST 2X QUAD, UL		

CARVER P/N	ITEM NO.	DESCRIPTION	REF DESIGNATORS	NOTES
118-60001-00	60	SPACER #6 1/8" HIGH		
118-80005-00	65	STANDOFF ROUND #8 x 1/4" x 5/16" ALUMINUM		X-fmr Mt. Rev.F
118-90004-00	70	STRAIN RELIEF MCT.156		
119-20001-00	75	TERMINAL STRIP 3 PIN		
151-20002-00	80	SCREW MACH PP BLK 4-40 x 3/8"		
151-20003-00	85	SCREW MACH PP BLK 4-40 x 1/2"		
151-20007-00	90	SCREW MACH PP BLK 4-40 x 5/16"		
151-20052-00	95	SCREW MACH PP BLK 6-32 x 3/8"		
151-20060-00	100	SCREW MACH PP BLK 6-32 x 1-1/4"		X-fmr Mt. Rev.F
151-20106-00	105	SCREW MACH PP BLK 8-32 x 3/4"		
151-20151-01	110	SCREW MACH PP ZC 10-32 x 1/4"		
151-20154-00	115	SCREW MACH PP BLK 10-32 x 9/16"		Front Panel
151-30002-00	120	SCREW SHT MTL PP BLK 4 x 3/8" 'A'		
151-30051-00	123	SCREW SHT MTL PP BLK 6 x 1/4" 'B'		
151-30052-00	125	SCREW SHT MTL PP BLK 6 x 3/8" 'B'		
151-30163-00	130	SCREW SHT MTL PP BLK 6 x 1/2" 'A'		
152-00001-00	135	NUT HEX 6-32 x 5/16" ZC		
152-10001-00	140	KEPNUT 4-40 ZC		
152-10002-00	145	KEPNUT 6-32 x 5/16" ZC		X-fmr Mt. Rev.F
152-10003-00	150	KEPNUT 8-32 x 11/32" ZC		
154-00007-00	155	WASHER BELLEVILLE #4 BLK OX		
154-00302-00	160	WASHER/F BK STL.16ID x .53OD x .03		X-fmr Mt. Rev.F
154-10051-00	165	WASHER FLAT SAE BL #6		X-fmr Mt. Rev.F
154-20052-00	167	WASHER INT LOCK SAE BK #6		
154-40002-01	170	WASHER SHLDR NYL WHT #4		
154-40007-01	175	WASHER SHLDR TEFL #4 .050		
159-50001-00	180	TYRAP 3-3/8" L WHT		
159-50004-00	185	TYRAP 7.4" L NTRL		
201-00026-00	190	CAP CER DISC680 PF 10% 1000V	C25	Add at Rev.L
204-00033-00	195	CAP MYLAR .33μF 400V		BINDING POST
205-00081-00	200	CAP FILTER LYTC 8000μF 125V		
253-30025-00	210	RES WIRE WOUND 2.7 OHM 3W		BINDING POST BTM
253-50041-00	215	RES WIRE WOUND FXD .20 OHM 20W 10%		BINDING POST TOP
255-10137-00	220	RES MET OXIDE 20 K R68		Add at Rev.H
315-13002-00	225	FUSE MDA12		
318-20001-00	230	SWITCH ROCKER SPDT BLK		
318-50004-00	235	SWITCH THERMAL U1210005310A		
319-00027-00	240	RECTIFIER BRIDGE 200V 25AMP		
319-00063-00	86	TRIAC T03 F/P 35AMP 600V MOT	MT1,MT2	* Rev.N Parts List
401-00952-00	250	MONSTER CABLE SPECIAL 1A		14.5" LEFT AMP, 11.5" RIGHT AMP
401-10101-00	255	WIRE 18 AWG TEW BLK 2.5'		
401-10103-00	260	WIRE 18 AWG TEW BLK 4.5'		
401-10142-00	265	WIRE 18 AWG TEW BLK 7.5'		
401-10171-00	270	WIRE 18 AWG TEW VIOLET 3.25'		
401-10502-00	275	WIRE 22 AWG TR-84 BLK 7'		Add at Rev.K
401-20104-00	280	BUSS WIRE 18 GAGE		
401-90012-00	285	LINECORD 16/2 POLARIZED		

CARVER P/N	ITEM NO.	DESCRIPTION	REF DESIGNATORS	NOTES
402-10002-00	290	TUBING HEAT SHRINK CLEAR 1/4"		
403-10002-00	297	CAULK BLK LATEX		
403-10003-00	300	SEALANT SILICONE RUBBER RTV		
403-10005-00	306	LOCKTITE (50CC)		
403-10007-00	303	PLASTIC ADHESIVE		
403-20001-00	310	THERMALCOTE #253		
403-40002-00	313	WEATHER STRIP 3/8" x 3/8"		
403-40014-00	315	TAPE FOAM WEATHERSTRIP 3/8" x 1/4"		
403-40017-00	317	TAPE FOAM DOUBLE		Add to back of Display Board
502-30031-01	320	CHASSIS SCREEN M-4.0t		
503-40022-01	325	PANEL FRONT SCREENED ANODIZED GRAY M-4.0t		Anodized Version
503-40056-01	325	PANEL FRONT SCREENED CHARCOAL BLACK M-4.0t		Charcoal Version
503-40063-01	325	PANEL FRONT SCREENED CHARCOAL BLACK TFM-4.0		
504-20035-01	327	COVER TOP PAINTED BLK M-4.0t		
506-20004-01	330	PLATE BOTTOM COVER M-4.0t		
507-00050-00	335	BRACKET THERMAL SW UNIVERSAL		
509-10001-01	340	FERRULE 5/16" ANODIZED GRAY		Front Panel Anodized Version
509-10001-03	340	FERRULE 5/16" PRO PAINT		Front Panel Charcoal Version
510-10001-01	345	HANDLE 2" ANODIZED GRAY		Anodized Version
510-10001-03	345	HANDLE 2" PRO PAINT		Charcoal Version
511-10003-01	350	HEATSINK TRANSISTOR M-4.0t		
512-10618-00	355	INSULATOR SIL-PAD K-6		
602-00576-00	370	ASSY T/U AMP M-4.0t		
602-00577-00	375	ASSY T/U POWER SUPPLY M-4.0t		
602-00578-00	380	ASSY T/U REGULATOR M-4.0t		
602-00579-00	385	ASSY T/U DISPLAY M-4.0t		
615-00002-00	390	NOISE FILTER TDKZCB2206-02, Safety Approved		* Rev.D Charcoal Version Parts List 
617-10032-01	395	TRANSFORMER M-4.0t CSA		* Rev.E Charcoal Version Parts List 

***HISTORY**

X-fmr Mounting Rev.A-E

151-20107-00		Screw PP Blk 8-32 x 1.00"		
152-10003-00		Keplnut 8-32 x 11/32"		
152-30001-00		Wellnut Threaded 8-32		
154-10101-00		Washer #8		
512-00004-00		Spacer #8 .375OD x .20L		
319 00027 00		TRIAC T03 F/P 25AMP 600V MOT	MT1,MT2	Rev.A-M Parts List 
615 00001-00		NOISE FILTER TDK ZCB2206-11		All Gray Anodized Versions, Rev.A-C Charcoal Parts List 
617-10032-00		TRANSFORMER M-4.0t		All Gray Anodized Versions, Rev.A-D Charcoal Parts List 

TFM42/45 AMP BOARD
P/N 602-00582-00

CAPACITORS

CARVER P/N	DESCRIPTION	REF DESIGNATORS	NOTES
201-00001-00	CAP CER DISC 5pF 10% 1000V	C21,24	
201-00004-00	CAP CER DISC 22pF 10% 1000V	C4	
201-00006-00	CAP CER DISC 39pF 10% 1000V	C18	
201-00012-00	CAP CER DISC 100pF 10% 1000V	C8,9	
201-00023-00	CAP CER DISC 470pF 10% 1000V	C15	
201-00026-00	CAP CER DISC 680pF 10% 1000V	C11	
201-00040-00	CAP CER DISC 15pF 10% 1000V	C13	
204-00003-00	CAP MYLAR .001μF	C16,17	
204-00008-00	CAP MYLAR .0027μF	C24,26	
204-00015-00	CAP MYLAR .01μF	C6	
204-00022-00	CAP MYLAR .033μF 10%	C22,23	
205-00006-00	CAP LYTIC 4.7μF 50V RAD	C12	
205-00010-00	CAP LYTIC 10μF 35V RAD	C1,2	
205-00013-00	CAP LYTIC 47μF 16V RAD	C19,20	
205-00021-00	CAP LYTIC 470μF 16V RD	C5	
205-00078-00	CAP LYTIC 3.3μF 160V	C10,14	

RESISTORS

CARVER P/N	DESCRIPTION	REF DESIGNATORS	NOTES
250-00005-00	RES FL RTD 150 OHM 1/4W PREP .4	R33,41	
250-00008-00	RES FL RTD 43 OHM 1/4W PREP .4	R34	
251-00014-00	RES CFILM 4.7 OHM 1/4W PREP .4	R36,40,74,82	
251-00036-00	RES CFILM 39 OHM 1/4W PREP .4	R66,73	
251-00038-00	RES CFILM 47 OHM 1/4W PREP .4	R87	
251-00041-00	RES CFILM 62 OHM 1/4W PREP .4	R88	
251-00046-00	RES CFILM 100 OHM 1/4W PREP .4	R45,48	
251-00050-00	RES CFILM 150 OHM 1/4W PREP .4	R63,64	
251-00054-00	RES CFILM 220 OHM 1/4W PREP .4	R42,86,90	
251-00060-00	RES CFILM 390 OHM 1/4W PREP .4	R83,91	
251-00061-00	RES CFILM 430 OHM 1/4W PREP .4	R43	
251-00063-00	RES CFILM 510 OHM 1/4W PREP .4	R75,81	
251-00065-00	RES CFILM 560 OHM 1/4W PREP .4	R30,44	
251-00066-00	RES CFILM 680 OHM 1/4 W PREP .4	R60,78	
251-00067-00	RES CFILM 750 OHM 1/4W PREP .4	R9,46,47	*Rev.D Parts List
251-00069-00	RES CFILM 910 OHM 1/4 W PREP .4	R2,27	
251-00074-00	RES CFILM 1.5 K 1/4W PREP .4	R18,19,24,25	
251-00078-00	RES CFILM 2.2 K 1/4W PREP .4	R55,58	
251-00081-00	RES CFILM 3 K 1/4W PREP .4	R33,76,79	
251-00084-00	RES CFILM 3.9 K 1/4W PREP .4	R77,80	

CARVER P/N	DESCRIPTION	REF DESIGNATORS	NOTES
251-00088-00	RES CFILM 5.6 K 1/4W PREP .4	R4	
251-00094-00	RES CFILM 10 K 1/4W PREP .4	R17,20,23,26,29	
251-00098-00	RES CFILM 15 K 1/4W PREP .4	R3	
251-00103-00	RES CFILM 24 K 1/4W PREP .4	R67,72	
251-00104-00	RES CFILM 27 K 1/4W PREP .4	R13	
251-00105-00	RES CFILM 30 K 1/4W PREP .4	R14	
251-00106-00	RES CFILM 33 K 1/4W PREP .4	R37	
251-00110-00	RES CFILM 47 K 1/4W PREP .4	R21	
251-00112-00	RES CFILM 56 K 1/4W PREP .4	R16,54,59	
251-00118-00	RES CFILM 100 K 1/4W PREP .4	R68,71	
251-00134-00	RES CFILM 470 K 1/4W PREP .4	R5	
251-10083-00	RES CFILM 3.6 K 1/2W PREP .5	R56,57	
251-10089-00	RES CFILM 5.6K 1/2W PREP .5	R68,70	
251-10108-00	RES CFILM 39 K 1/2W PREP .5	R49,52,61	
251-10109-00	RES CFILM 43 K 1/2W PREP .5	R62,65	
252-00285-00	RES MFILM 809 OHM 1/4W 1% .4	R6	
252-00355-00	RES MFILM 1K 1/4W 1% .4	R7	
252-00356-00	RES MFILM 1.21 K 1/4W 1% .4	R11	
252-00367-00	RES MFILM 4.32 K 1/4W 1% .4	R15	
252-00385-00	RES MFILM 12.1 K 1/4W 1% .4	R8,10	
252-00420-00	RES MFILM 24.3 K 1W 1% .4	R12	
252-00427-00	RES MFILM 31.8 K 1/4W 1% .4	R39	
253-20001-00	RES WIRE WOUND .1 OHM 2W	R84,92,93,96	
253-40000-00	RES WIRE WOUND .05 OHM 5W 10%	R94,95,97	
255-20109-00	RES MET OXIDE 1.8 K 2W	R50	
259-20001-00	TRIM POT 1 K PCB MT	RP1	
259-30001-00	POT 500 OHM MINI	RP2	* Rev.D Parts List
*HISTORY			
251-00067-00	RES CFILM 750 OHM 1/4W PREP .4	R46,47	Rev.A-C Parts List
259-20010-00	TRIM POT 2.0 K PCB MT	RP2	Rev.A-C Parts List

DIODES

CARVER P/N	DESCRIPTION	REF DESIGNATORS	NOTES
320-20001-00	DIODE 1N4148 75V PREP .4	D1,2,4-6,10,16,33, 34,38,39	
320-20004-00	DIODE 1N4004 400V PREP .4	D12,15,17,18,19,20,21,22,23,24,25,32	
320-20006-00	DIODE FDH 400 400V PREP .4	D7,8,9,13,14	
320-20007-03	DIODE MR 852 UNPREP	D28-31	
320-30006-00	DIODE ZENER 1N4738 8.2V PREP .4	D35,36	

TRANSISTORS

CARVER P/N	DESCRIPTION	REF DESIGNATORS	NOTES
321-10000-00	XISTOR 152 NPN 5M SG MPS W06	Q13	
321-10001-00	XISTOR 152 PNP 3M SG MPS 6729	Q15	
321-20001-00	XISTOR 202 NPN POW MPS U10	Q7	
321-20002-00	XISTOR 202 PNP POW MPS U60	Q4	
321-30013-00	XISTOR T03P(L) NPN PWR 28C3281	Q11,17,18,19,20	
321-30014-00	XISTOR T03P(L) PNP PWR 2SA1302	Q12,22,23,24,25	
321-40000-00	XISTOR T092 NPN 3M SG MPS 8087	Q21	
321-40001-00	XISTOR T092 NPN 3M SG MPS A43	Q2,9	
321-40003-00	XISTOR T092 MPS 8083(SUB FPN4)	Q6	
321-40004-00	XISTOR T092 PNP 3M SG MPS A83	Q3,10	
321-40005-00	XISTOR T092 JFET 3M SG 2N 5458	Q1	
321-60004-00	XISTOR T0220 NPN 2N6488	Q14	
321-60006-00	XISTOR T0220 PNP 2N6490	Q16	
321-60007-00	XISTOR T0225AA NPN PWR MJE 180	Q6	

INTEGRATED CIRCUITS

CARVER P/N	DESCRIPTION	REF DESIGNATORS	NOTES
330-30002-00	IC OPAMP BIFET TL081	U1	
330-30001-00	IC DUAL OP AMP BIFET TL072	U2	



MISCELLANEOUS ITEMS

CARVER P/N	DESCRIPTION	REF DESIGNATORS	NOTES
160-20012-00	CONNECTOR 15 PIN	J2	
204-00052-00	CAP MYLAR .68 μ F 10%	C3	
401-00852-00	MONSTER CABLE SPECIAL	WPA	
401-30002-00	JUMPER INSUL .3"	U2	
401-30003-00	JUMPER INSULATED .4"	JP2,4,5,8,14-19,21,22	
401-30005-00	JUMPER INSULATED .5"	JP13,20	
401-30006-00	JUMPER INSULATED .6"	JP7,12	
401-30007-00	JUMPER INSULATED .7"	JP3	
401-30013-00	JUMPER INSULATED .8"	JP1,9,10,11	
401-30014-00	JUMPER INSULATED .9"	JP6	
403-10003-00	SEALANT SILICONE RUBBER RTV		
501-00582-00	PCB AMP TFM-42/45		

TFM-42/45 POWER SUPPLY BOARD

P/N 602-00574-XX

CAPACITORS

CARVER P/N	DESCRIPTION	REF DESIGNATORS	NOTES
201-00006-00	CAP CER DISC 39pF 10% 1000V	C24	
201-00034-00	CAP CER DISC .01μF 20 % 500V	C22	
201-00041-00	CAP CER DISC 56pF 10% 1000V	C23	
205-00002-00	CAP LYTIC 2.2μF 35V RAD	C7	
205-00011-00	CAP LYTIC 22μF 16V RAD	C18,19	
205-00013-00	CAP LYTIC 47μF 25V RAD	C3,16,17	
205-00014-00	CAP LYTIC 47μF 50V RAD	C6	
205-00015-00	CAP LYTIC 100μF 10V RAD	C2	
205-00034-00	CAP LYTIC 47μF 10V 20% RAD	C11	
205-00041-00	CAP LYTIC 22μF 5V 20% RAD	C8	
205-00053-00	CAP LYTIC 1μF 16V 10% RAD	C9,10	TFM-42 only
205-00079-00	CAP LYTIC 3300μF 35V RAD	C14,15	
205-00080-00	CAP LYTIC 200μF 80V RAD	C20,21	

RESISTORS

CARVER P/N	DESCRIPTION	REF DESIGNATORS	NOTES
250-00004-00	RES FL RTD 82 OHM 1/4 W .4	R57	
250-00006-00	RES FL RTD 270 OHM 1/4W .4	R55	
251-00066-00	RES CFILM 680 OHM 1/4W PREP .4	R2,3,12,14,61	
251-00067-00	RES CFILM 750 OHM 1/4W PREP .4	R8	
251-00070-00	RES CFILM 1K 1/4W PREP .4	R13,25,65	R65 on TFM-45 only
251-00078-00	RES CFILM 2.2K 1/4W PREP .4	R52	
251-00080-00	RES CFILM 2.7K 1/4W PREP .4	R66	TFM-45 only
251-00082-00	RES CFILM 3.3K 1/4 W PREP .4	R9	
251-00083-00	RES CFILM 3.6K 1/4 W PREP .4	R10	
251-00087-00	RES CFILM 5.1K 1/4W PREP .4	R8,56,58,62,63	
251-00094-00	RES CFILM 10K 1/4W PREP .4	R18	
251-00102-00	RES CFILM 22K 1/4W PREP .4	R24	
251-00103-00	RES CFILM 24K 1/4W PREP .4	R26	
251-00104-00	RES CFILM 27K 1/4W PREP .4	R53	
251-00105-00	RES CFILM 30K 1/4W PREP .4	R11,34	
251-00107-00	RES CFILM 36K 1/4W PREP .4	R30,31,36,37	TFM-42 only
251-00110-00	RES CFILM 47K 1/4W PREP .4	R60,64	*Rev.K
251-00120-00	RES CFILM 120K 1/4W PREP .4	R42	
251-00121-00	RES CFILM 130K 1/4W PREP .4	R1,4,27,28	R27,28 on TFM-42 only
251-00122-00	RES CFILM 150K 1/4W PREP .4	R35	
251-00125-00	RES CFILM 200K 1/4W PREP .4	R21	
251-00126-00	RES CFILM 220K 1/4W PREP .4	R29	
251-00132-00	RES CFILM 390K 1/4W PREP .4	R23	
251-10080-00	RES CFILM 2.7K 1/4W PREP .4	R45,47	
251-00134-00	RES CFLIM 470K 1/4W PREP .4	R20,22	

CARVER P/N	DESCRIPTION	REF DESIGNATORS	NOTES
255-10115-00	RES MET OXIDE 1.3 K 1W	R48 CRIMP	TFM-42 only
255-10118-00	RES MET OXIDE 1.1 K 1W	R50 CRIMP	
255-10120-00	RES MET OXIDE 9.1 K 1W	R54	
255-10133-00	RES MET OXIDE 15 K 1W	R49 CRIMP	
255-10136-00	RES MET OXIDE 18 K 1W	R48 CRIMP	
255-10137-00	RES MET OXIDE 20 K 1W	R44	
255-10150-00	RES MET OXIDE 82 K 1W	R5,7 CRIMP	
255-20083-00	RES MET OXIDE 3 K 2W	R67	TFM-45 only *Rev.D
255-20095-00	RES MET OXIDE 680 OHM 2W	R43,51,48	Crimp R48 TFM-45 only
		R69,70	TFM-45 only, Mount circuit side behind C14 *Rev.C
259-20003-00	TRIM POT 5K PCB MOUNT	RP1	

*HISTORY

251-00118-00	RES CFILM 100K 1/4W PREP .4	R60,64	Rev.A-J
253-20100-00	RES WIRE WOUND 820 OHM 2W	R39	TFM-45 only Rev.A-B
255-20072-00	RES MET OXIDE 130 OHM 2W	R67	TFM-45 only Rev.A-C

DIODES

CARVER P/N	DESCRIPTION	REF DESIGNATORS	NOTES
320-20001-00	DIODE 1N4148 75V PREP .4	D2-7,9-11,24,25	D9,10 TFM-42 only
320-20010-03	DIODE 6 AMP 200V UNPREP	D14-17 CRIMP	 *Rev.F
320-30002-00	DIODE ZENER 1N4744 15V PREP .4	D8	
320-30009-00	DIODE ZENER 1N4735 602V PREP .4	D1,27	TFM-45 only
320-30001-00	DIODE ZENER 1N4742 12V PREP .6	D22,23,28	

*HISTORY

320-20010-03	DIODE 6 AMP 200V UNPREP	D14-21 CRIMP	 Rev.A-E
--------------	-------------------------	--------------	---

TRANSISTORS

CARVER P/N	DESCRIPTION	REF DESIGNATORS	NOTES
321-40009-00	XISTOR TO92 PNO SM SG 2N4125	Q4,5	TFM-42 only
321-40010-00	XISTOR TO92 NPN SM SG 2N4123	Q3,6,7,8,12	Q6,7 TFM-42 only, Q12 TFM-45 only
321-40012-00	XISTOR TO92 PNP SM SG MPSA56	Q2	
321-60000-00	XISTOR TO220 NPN PWR MJE3055	Q11	TFM-45 only
321-90000-00	XISTOR B100 PNP PWR 2SA1360	Q10	
321-90001-00	XISTOR B100 NPN PWR 2SC3423	Q9	

INTEGRATED CIRCUITS

CARVER P/N	DESCRIPTION	REF DESIGNATORS	NOTES
330-30001-00	IC DUAL OP AMP BIFET TL072	U2	
330-30008-00	IC DUAL OP AMP 4558	U1	

MISCELLANEOUS ITEMS

CARVER P/N	DESCRIPTION	REF DESIGNATORS	NOTES
109-10006-00	PHONO JACK DUAL PC MOUNT	J3	
160-20009-00	CONNECT 3 PIN GOLD	J1	
160-20010-00	CONNECT 4 PIN	J5	TFM-42 only
160-20011-00	CONNECT 5 PIN	J6	TFM-45 only
160-30029-00	HEADER 15 PIN .156	J2,4	
318-10009-00	SW PUSH 1KEY NO FRAME MINI	SW1	
401-10117-01	WIRE 18 AWG TR-64 BROWN 7'	WP-T	
401-10129-01	WIRE 18 AWG TEW BROWN 5'		Add at Rev.F
401-10158-00	WIRE 18 AWG TEW WHITE 5'		Add at Rev.F
401-10193-00	WIRE 18 AWG TR64 RED 4.75'	WP-P	
401-10580-00	WIRE 22 AWG TR-64 ORANGE 15.75'	WP-S	
401-30002-00	JUMPER INSUL .3'	JP4,6,24	
401-30003-00	JUMPER INSUL .4'	JP2,9,16,17,20,21,22	
401-30005-00	JUMPER INSUL .5'	JP1,8	
401-30006-00	JUMPER INSUL .6'	JP7,10,15	
401-30007-00	JUMPER INSUL .7'	JP5,11	
401-30013-00	JUMPER INSUL .8'	JP3,12,13,14,19,23,25	J25 add at Rev.D, TFM-45 only
402-10005-00	TUBING HEATSHRINK		USE ON ANODE END OF D14
401-40008-00	WIRE T #22 1EA GRN/WH, BLK 9'		BLK WP-Q TO WP-M, GRN/WH WP-R TO WP-K
401-40009-00	WIRE T #22 1EA WHT/RED, BLK 7'		BLK WP-N TO WP-L, RED/WHT WP-O TO WP-J
501-00574-00	PCB POWER SUPPLY TFM-42/45		

HISTORY

401-10629-00	WIRE 22AWG TR-64 ORANGE 2.0' C26		Remove at Rev.F
--------------	----------------------------------	--	-----------------

TFM-42/45 REGULATOR BOARD P/N 602-00580-XX

CAPACITORS

CARVER P/N	DESCRIPTION	REF DESIGNATORS	NOTES
204-00015-00	CAP MYLAR .01 μ F	C3	
204-00031-00	CAP MYLAR .33 μ F	C4	
207-10010-00	CAP MET POLY .1 μ F/250V Rad	C5	

RESISTORS

CARVER P/N	DESCRIPTION	REF DESIGNATORS	NOTES
251-00014-00	RES CFILM 4.7 OHM 1/4W PREP .4	R10	
251-00030-00	RES CFILM 22 OHM 1/4W PREP .4	R5	
251-00098-00	RES CFILM 15K 1/4W PREP .4	R3	
251-00100-00	RES CFILM 18K 1/4W PREP .4	R9	

CARVER P/N	DESCRIPTION	REF DESIGNATORS	NOTES
251-00118-00	RES CFILM 100K 1/4W PREP .4	R6,7	
251-00124-00	RES CFILM 180K 1/4W PREP .4	R8	
251-00135-00	RES CFILM 510K 1/4W PREP .4	R4	
251-10036-00	RES CFILM 30 OHM 1/2W PREP .5	R11	*Rev.C
251-10109-00	RES CFILM 43K 1/2W PREP .5	R2	
251-10156-00	RES CFILM 3.9M 1/2W PREP .5	R1	

***HISTORY**

251-10022-00	RES CFILM 10 OHM 1/2W PREP .5	R11	Rev.A-B
--------------	-------------------------------	-----	---------

DIODES

CARVER P/N	DESCRIPTION	REF DESIGNATORS	NOTES
320-20004-00	DIODE 1N4004 400V PREP	D1-6	

TRANSISTORS

CARVER P/N	DESCRIPTION	REF DESIGNATORS	NOTES
321-40011-00	XISTOR T092 NPN SM 9G MPSA06	Q1,3	
321-40012-00	XISTOR T092 PNP SM 9G MPSA56	Q2,4	

INTEGRATED CIRCUITS

CARVER P/N	DESCRIPTION	REF DESIGNATORS	NOTES
330-40002-00	OPTOISOLATOR PHOTOCOUPLER	U1	

MISCELLANEOUS ITEMS

CARVER P/N	DESCRIPTION	REF DESIGNATORS	NOTES
101-22001-00	BRACKET RECT PCB MNT 1/2"		
159-20001-00	POP RIVET CE 1/8		USE ON BRACKET
318-00002-00	SWITCH CONV 115/223 1A 125 VAC		
318-50006-01	SWITCH, THERMAL PEPI		* Rev.P
401-10126-00	WIRE 18 AWG TEW BL	WP-K,WP-S	
401-10132-00	WIRE 18 AWG TEW BL	WP-B,WP-A	
401-10581-00	WIRE 22 AWG TR 64	WP-P	
401-20204-00	BUSS WIRE 22 GAGE	WP-C	
403-10003-00	SEALANT SILICONE R		USE ON C-4
501-00580-00	PCB REG TFM 42/45		
550-00002-00	CBL .250 #18 TEW RED 2.5'	WP-L	Add at Rev.E
550-00002-01	CBL .250 #18 TEW BLUE 2.5'	WP-M	Add at Rev.E
550-00009-00	CBL .250 #18 TEW ORANGE 2.5'	WP-N	Add at Rev.E

***HISTORY**

318-50004-00	SWITCH, THERMAL U1210005310A		Rev.A-D
--------------	------------------------------	--	---------

CARVER TFM-42 FRONT PANEL ASSEMBLY
P/N 503-50001-00

CAPACITORS

CARVER P/N	DESCRIPTION	REF DESIGNATORS	NOTES
S7-50TW1R0M-RT CAP LYTIC	1 μ F/50V	C601,602	

RESISTORS

CARVER P/N	DESCRIPTION	REF DESIGNATORS	NOTES
KA25ST103J-AT	RES CFILM 10 K 1/4W	R615,619	
KA25ST134J-AT	RES CFILM 130 K 1/4W	R621,622	
KA25ST222J-AT	RES CFILM 2.2 K 1/4W	R623,624	
KA25ST272J-AT	RES CFILM 2.7 K 1/4W	R620	
KA25ST303J-AT	RES CFILM 30 K 1/4W	R607-R618	
KA25ST752J-AT	RES CFILM 7.5 K 1/4W	R601-R606	
KA50XT222J-AT	RES CFILM 2.2 K 1/2W	R613,614	

DIODES

CARVER P/N	DESCRIPTION	REF DESIGNATORS	NOTES
1N4002-AT	DIODE 1N4002	D617,618	
1SS176-AT	DIODE 1SS176	D615,616	
SLP1710	LED, RED	D601-D612	
SLP471D	LED, YELLOW	D613,614	

INTEGRATED CIRCUITS

CARVER P/N	DESCRIPTION	REF DESIGNATORS	NOTES
NJM2902N	IC NJM2902N	IC601,602	

MISCELLANEOUS ITEMS

CARVER P/N	DESCRIPTION	REF DESIGNATORS	NOTES
B3B-EH-A	CONNECTOR	CN401	
B4B-EH-A	CONNECTOR	CN452	
B5B-EH-A	CONNECTOR	CN802	
ESB-00713V	POWER SWITCH	SW701	
LD-813	PCB, TFM-42 LED BOARD		
MZ03-777	MICRO SOCKET	MC401	
MZ04-773	MICRO SOCKET	MC452	

CARVER P/N	DESCRIPTION	QTY
N21755-1	FRONT PANEL, TFM-42	1
N21791-1	FRONT BASE, TFM-42	1
N31103-4	SUB PANEL R, TFM-42	1
N44092-BK1	HANDLE SPACER	4
N44093A-BK1	HANDLE	2
N45417-BK	PUSH BUTTON	1
N45659-1	SUB PANEL L, TFM-42	1
N45715	ANGLE (SWITCH)	1
N45751	LED SPACER	2
N45764-0	SUB PANEL C, TFM-42	1
SSPS2+40X10-B	SCREW-SP ASSY, PAN HEAD, B	4
TPM+30X08-Y	TAP SCREW P, ROUND HEAD, Y	2
TPPW07+26X08-Y	TAP SCREW P-W ASSY, P HEAD, Y	4
TSB+30X06-Y	TAP SCREW S, BIND HEAD, Y	2

CARVER TFM-45 FRONT PANEL ASSEMBLY

P/N 503-50002-00

CAPACITORS

CARVER P/N	DESCRIPTION		REF DESIGNATORS	NOTES
NS-16TW101M-RT	CAP LYTIC	100 μ F/16V	C411-C414	
NS-16TW220M-RT	CAP LYTIC	22 μ F/16V	C401,402,405,406	
NS-25TW100M-RT	CAP LYTIC	10 μ F/25V	C451	
NS-25TW470M-RT	CAP LYTIC	47 μ F/25V	C415,416	
NS-50TW47M-RT	CAP LYTIC	4.7 μ F/50V	C409,410	
HE40SJSL470KRT	CAP CER DISC	47pF	C403,404	
HE50SJSL101KRT	CAP CER DISC	100pF	C407,408	
HE70SJSL103ZRT	CAP CER DISC	.01 μ F	C417,418	

RESISTORS

CARVER P/N	DESCRIPTION		REF DESIGNATORS	NOTES
KA16ST101J-AT	RES CFILM	100 OHM	R417,418	
KA16ST102J-AT	RES CFILM	1 K	R415,416	
KA16ST133J-AT	RES CFILM	13 K	R403,404	
KA16ST155J-AT	RES CFILM	1.5 M	R401,402	
KA16ST180J-AT	RES CFILM	18 OHM	R421,422	
KA16ST202J-AT	RES CFILM	2 K	R413,414	
KA16ST203J-AT	RES CFILM	20 K	R408,410	
KA16ST304J-AT	RES CFILM	300 K	R429,430	
KA16ST394J-AT	RES CFILM	390 K	R419,420	
KA16ST432J-AT	RES CFILM	4.3 K	R411,412	
KA16ST472J-AT	RES CFILM	4.7 K	R453	Add 1K ohm 1/4W resistor in parallel to R453 at Rev.B
KA16ST473J-AT	RES CFILM	47 K	R405,406	
KA16ST561J-AT	RES CFILM	560 OHM	R407,408	
KA16ST562J-AT	RES CFILM	5.6 K	R454	
KA16ST820J-AT	RES CFILM	82 OHM	R427,428	
KA16ST911J-AT	RES CFILM	910 OHM	R423-R426	
EVJ-2KA323B14	POTENTIOMETER	10KB	VR451	
SVR-06S3B504	TRIM POT	500 K	VR401,402	

TRANSISTORS

CARVER P/N	DESCRIPTION		REF DESIGNATORS	NOTES
29C1815-Y,GRRT	XISTOR	29C1815	Q401-Q404	

DIODES

CARVER P/N	DESCRIPTION	REF DESIGNATORS	NOTES
1SS176-AT	DIODE	1SS176	D401,402

INTEGRATED CIRCUITS



CARVER P/N	DESCRIPTION	REF DESIGNATORS	NOTES
NJM4558L	IC	NJM4558	IC401,402

MISCELLANEOUS ITEMS

CARVER P/N	DESCRIPTION	REF DESIGNATORS	NOTES
BF310-05081A	LAMP 12V,0.15A	PL451,452	
B3B-EH-A	CONNECTOR	CN401	
B4B-EH-A	CONNECTOR	CN802	
B5B-EH-A	CONNECTOR	CN451	
S2B-EH	CONNECTOR	CN452	
S4B-EH	CONNECTOR	CN402	
ESB-89713V	POWER SWITCH		
KL290B-20	METER	M401,402	
LD-814	PCB		
MD-814	PCB		
MZ02-761	MICRO SOCKET	MC452	
MZ03-763	MICRO SOCKET	MC401	
MZ04-764	MICRO SOCKET	MC402	
MZ05-765	MICRO SOCKET	MC451	

CARVER P/N	DESCRIPTION	QTY
N21755-1	FRONT PANEL	1
N31103-3	SUB PANEL, R	1
N10545-1	FRONT BASE	1
N44092-BK1	HANDLE SPACER	4
N44093A-BK1	HANDLE	2
N44260-T-BK1	KNOB 12	1
N45417-BK	PUSH BUTTON	1
N45659-1	SUB PANEL, L	1
N45660-1	SUB PANEL, C	1
N45667	INSULATION PLATE	2
N45658	METER BRACKET	1
N45715	ANGLE (SWITCH)	1
SSPS2+40X10-B	SCREW-SP ASSY, PAN HEAD, B	4
TBB+26X08-Y	TAP SCREW B, BIND HEAD, Y	2
TPM+30X08-Y	TAP SCREW P, ROUND HEAD, Y	2
TPPW07+26X08-Y	TAP SCREW P-W ASSY, P HEAD, Y	3
TSB+30X06-Y	TAP SCREW S, BIND HEAD, Y	2

TFM-42/45 FINAL ASSEMBLY
P/N 607-00407-00 TFM-42
607-00408-00 TFM-45

CARVER P/N	ITEM NO.	DESCRIPTION	REF DESIGNATORS	NOTES
101-30001-00	5	BUMPONS RUBBER ROUND MED		
101-22006-00	8	BRACKET MNT .060 .687 x 1.062		X-fmr Shield, Add at Rev.T
102-00003-00	10	CAP PROTECTOR .25		
104-00001-00	12	EDGING NYLON .094"		X-fmr Shield, Add at Rev.T
105-40014-00	15	FUSEHOLDER PANEL MNT120V/230V		
105-50000-00	17	FUSE CARRIER 120V		
106-30002-00	20	GROMMET GUM		
108-00102-00	25	INSUL RAG PAPER .015"		
111-00002-00	30	LABEL MONSTER CABLE		
111-20051-00	35	SOLDER LUG #6		Triac, Speaker Term.
111-20101-00	37	SOLDER LUG #8		Transformer
111-20151-00	40	SOLDER LUG #10		Filter Cap
112-20003-00	50	MOUNT TYRAP, SCREW MNT		130V Filter Cap
115-30007-00	55	BINDING POST 2x QUAD, UL	J7	
118-60012-00	65	SPACERS 5/8" x 7/16" OD x 1/4" ID ALUMINUM		
118-80005-00	67	STANDOFF ROUND #8 x 1/4" x 5/16" ALUMINUM		X-fmr Mt
118-90004-00	70	STRN RELIEF MCT.156 WS.15 x .28 18/2		
119-20001-00	75	TERMINAL STRIP 3 PIN	TB1	
151-20001-00	77	SCREW MACHPP BLK 4-40 x 1/4"		Therm SW Brkt(1), Noise Filter (2), Term Strip (1)
151-20002-00	80	SCREW MACHPP BLK 4-40 x 3/8"		Small X-sistor
151-20003-00	90	SCREW MACHPP BLK 4-40 x 1/2"		Large X-sistor
151-20004-00	92	SCREW MACHPP BLK 4-40 x 9/16"		Use on CR2; Add at Rev.M
151-20051-00	91	SCREW MACHPP BLK 6-32 x 1/4"		Reg Bd Mnt
151-20052-00	95	SCREW MACHPP BLK 6-32 x 3/8"		Triac (2), Heatsink (8), Grnd Lug (1)
151-20101-00	96	SCREW MACHPP BLK 8-32 x 1-1/4"		Cap Mnt
151-20106-00	105	SCREW MACHPP BLK 8-32 x 3/4"		Bridge Rect
151-20109-00	107	SCREW MACH PP BLK		X-fmr Bolt
151-20151-01	110	SCREW MACHPP ZC 10-32 x 1/4"		Filter Caps
151-30002-00	120	SCREW SHT MTLPP BLK 4 x 3/8" 'A'		Front Panel Bottom Sides
151-30051-05	123	SCREW SHT MTLPP BLK 6 x 1/4" 'B'		Cover
151-30052-00	125	SCREW SHT MTLPP BLK 6 x 3/8"		Front Panel Sides
151-30052-10	126	SCREW SHT MTLPP BLK 6 x 3/8" 'A'		Front Panel Bottom Center
151-30163-00	130	SCREW SHT MTLPP BLK 6 x 1/2" 'A'		Speaker Post Assy (1), Input Jack (2)
152-00001-00	135	NUT HEX 6-32 x 5/16" ZC		Triac, Gnd Lug
152-10001-00	142	KEPNUT 4-40 ZC		Use on CR2; Add at Rev.M
152-10002-00	145	KEPNUT 6-32 x 5/16" ZC		Triac
152-10003-00	150	KEPNUT 8-32 x 11/32" ZC		X-fmr
154-00007-00	155	WASH BELLEVILLE #4 BLK OX		Output X-sistor
154-00302-00	160	WASH/F BKSTL.16ID x .53OD x .03		X-fmr Mnt
154-20052-00	167	WASH INT LOCK SAE BLK #6		Grnd Lug (1), Triac (1)
154-40008-01	175	WASH SHLDR NYL WHT #4		Driver X-sistors
159-20001-00	177	POP RIVET CE 1/8" .063-.125Grip		X-fmr Shield Mount, Add at Rev.T
159-50001-00	180	TYRAP 3-3/8" L WHT		
159-50004-00	185	TYRAP 7.4" L NTRL		Use to Mount C26,27

CARVER P/N	ITEM NO.	DESCRIPTION	REF DESIGNATORS	NOTES
204-00033-00	195	CAP MYLAR .33 μ F 400V	C28R,28L	Output Pole
205-00081-00	200	CAP FILTER LYTIC 9000 μ F 125V	C26,27	
253-30025-00	210	RES WIRE WOUND 2.7 OHM 3W	R98R,98L	Binding Post Btm
253-50041-00	215	RES WIRE WOUND FXD .20 OHM 20W 10%	R99R,99L	Binding Post Top
255-10137-00	220	RES MET OXIDE 20 K	R68	
315-13002-00	225	FUSE MDA12	F1	
318-00027-00	240	RECT BRIDGE 200V 25AMP	CR1	
319-00030-00	242	RECT BRIDGE 200V 6 AMP	CR2	Add at Rev.M
319-00063-00	245	TRIACT03 F/P 35AMP 600V MOT	Q13	
401-10101-00	255	WIRE 18 AWG TEW BLK 2.5'		Spker Post A TO Pwr Bd WP-U (1), Line Filter to Triac (1)
401-10194-00	257	WIRE 18 AWG TR64 RED 3.25'		Bridge to Cap
401-10103-00	260	WIRE 18 AWG TEW BLK 4.5'		Line Filter to Fuse
401-10142-00	265	WIRE 18 AWG TEW BLK 7.5'		Filter Cap
401-10502-00	275	WIRE 22 AWG TR-64 BLK 7'		X-fmr Mnt to Pwr Bd
401-20104-00	280	BUSS WIRE 18 GAGE		Speaker Term, Filter Cap
401-20204-00	282	BUSS WIRE 22 GAGE		Grnd Lug
401-90012-00	285	LINECORD 16/2 POLARIZED	P1	
403-10003-00	300	SEALANT SILICONE RUBBER RTV		
403-10007-00	303	PLASTIC ADHESIVE		Output Resistors
403-10020-00	305	LOCKTITE #222		X-fmr, Line Filter, Therm Sw, Apply Before Installing Screw
403-20001-00	310	THERMALCOTE #253		Under Trim
502-30070-01	320	CHASSIS SCREENED, TFM-42/45		
503-50001-00	325	PANEL FRONT ASSY TFM-42		TFM-42 Only
503-50002-00	325	PANEL FRONT ASSY TFM-45		TFM-45 Only
504-20061-01	327	COVER TOP TFM-42/45		
507-20066-00	335	BRACKET, THERMAL SWITCH PEPI		*Rev.P
511-00005-00	345	HEATSINK TRANSFORMER		X-fmr Shield, Add at Rev.T
511-10023-00	353	HEATSINK FAB TFM42/45		
512-10635-00	355	INSULATOR SIL-PAD K-6		
530-20029-00	363	LABEL, CITY OF LA		Add at Rev.J
530-20100-00	365	STICKER SERIAL #		One Label on Back of Chassis, One Label Inside of Chassis
602-00574-00	370	ASSY PCB PWR SUPP		
602-00580-00	373	ASSY PCB REGULATOR		
602-00582-00	375	ASSY PCB AMP TFM4		
615-00002-00	390	NOISE FILTER TDKZCB2206-02	FL1	
617-10032-00	395	TRANSFORMER, M-4.0X		
HISTORY				
108-00201-00		INSULATION, FIBERGLASS 1"		Rev.J-M, Delete at Rev.N
507-00060-00		BRACKET, THERMAL SWITCH UNIVERSAL		Rev.A-O

Appendix C DESIGN HISTORY

Engineering Change Orders for Model M-4.0t Magnetic Field Power Amplifier

Note: Revision levels for assemblies may be different than revision levels for parts lists and schematic diagrams.

ECO#:818	DATE: 08/12/88	REV.B Amp Board Assembly and Parts List - Effective S/N 61 REV.B Power Supply Board Assembly and Parts List REV.B Amp Schematic REV.B Power Supply Schematic
REASON FOR CHANGE:	Improve tube transfer function and commutator distortion.	
PROCEDURE:	On Amp Board change: C4, C15, R5, R11, R15 add: C22, C23, R60, R78 On Power Supply Board change: R16, R17, R60 add: C23, C24	
ECO#:844	DATE: 09/08/88	REV.E Final Assembly
REASON FOR CHANGE:	To reduce labor cost	
PROCEDURE:	Delete mica insulators and thermalcote from output transistors. Use sil-pads instead.	
ECO#:851	DATE: 09/21/88	REV.F Final Assembly - Effective S/N 246
REASON FOR CHANGE:	To reduce transformer buzz.	
PROCEDURE:	Add weatherstripping and black latex caulk. Modify transformer mounting technique.	
ECO#:852	DATE: 09/21/88	REV.E Amp Board Assembly REV.D Amp Board Parts List REV.D Amp Schematic - Effective S/N 246
REASON FOR CHANGE:	To improve frequency response.	
PROCEDURE:	Delete C7.	
ECO#:856	DATE: 09/27/88	REV.E Amp Schematic - Effective S/N 246 REV.E Amp Board Parts List
REASON FOR CHANGE:	To improve bias pot stability.	
PROCEDURE:	Change RP1 and R30.	
ECO#:873	DATE: 10/13/88	REV.F Amp Schematic REV.F Amp Board Parts List
REASON FOR CHANGE:	To prevent possible shutdown into low impedance loads.	
PROCEDURE:	Change Q9, Q10.	
ECO#:888	DATE: 11/16/88	REV.H Final Assembly - Effective S/N 821
REASON FOR CHANGE:	To prevent triac from misfiring.	
PROCEDURE:	Add 20k ohm 1W resistor to bridge rectifier (R68).	

ECO#:900-1	DATE: 01/03/89	REV.E Power Supply Board Parts List REV.B Power Supply Schematic - Effective S/N 1366 REV.K Final Assembly
REASON FOR CHANGE:	To reduce buzz with inputs unterminated.	
PROCEDURE:	On Power Supply Board change: R60, R61 Add: R64 On Final Assembly, wrap grounded wire around transformer secondary bundle.	
ECO#:907	DATE: 01/10/89	REV.L Final Assembly - Effective S/N 1246
REASON FOR CHANGE:	Reduce output noise.	
PROCEDURE:	Add: C25 between orange secondary wires.	
ECO#:939	DATE: 02/08/89	REV.G Amp Schematic - Effective S/N 1566 REV.H Amp Board Parts List
REASON FOR CHANGE:	Improve bias pot adjustment range.	
PROCEDURE:	Change: R30.	
ECO#:982	DATE: 03/20/89	REV.H Amp Schematic REV.J Amp Board Parts List
REASON FOR CHANGE:	Reduce possibility of excessive common mode conduction.	
PROCEDURE:	Change: RP1, R30, R87	
ECO#:1059	DATE: 06/01/89	REV.F Power Supply Board Parts List - Effective S/N 3055 REV.F Power Supply Schematic
REASON FOR CHANGE:	Reduce turn-off thump into capacitively coupled speakers.	
PROCEDURE:	Change: R54	
ECO#:1140	DATE: 06/29/89	REV.E1 Amp Board Assembly - Effective S/N 3255 REV.K Amp Board Parts List
REASON FOR CHANGE:	Prevent broken solder joints.	
PROCEDURE:	RTV C3 to the board.	
ECO#:1151	DATE: 07/13/89	REV.N Final Assembly Parts List - Effective S/N 3356
REASON FOR CHANGE:	To reduce triac failures.	
PROCEDURE:	Change triac from 25A to 35A rating.	
ECO#:1232	DATE: 10/02/89	REV.C Final Assembly Parts List (Charcoal Version) - Effective S/N 3596
REASON FOR CHANGE:	Part no longer required with sil-pads.	
PROCEDURE:	Delete shield plate.	
ECO#:1259	DATE: 10/02/89	REV.D Final Assembly Parts List (Charcoal Version)
REASON FOR CHANGE:	Use safety approved line filter.	
PROCEDURE:	Change line filter.	

ECO#:1270	DATE: 10/31/89	REV.J Amp Schematic REV.F Amp Board Assembly REV.E Final Assembly Parts List (Charcoal Version)
REASON FOR CHANGE:	To make damping adjustable. To conform to CSA standards.	
PROCEDURE:	Delete R9. Add RP2. Add CSA approved Transformer.	

Engineering Change Orders for Model TFM-42/TFM-45 Magnetic Field Power Amplifier
 Note: Revision levels for assemblies may be different than revision levels for parts lists and schematic diagrams.

ECO#:1347-2	DATE: 02/20/90	REV.C Regulator Board Assembly
REASON FOR CHANGE:	To prevent triac from unlatching under certain conditions.	
PROCEDURE:	Change R11.	

ECO#:1437	DATE: 04/17/90	REV.C Power Supply Board Assembly REV.C Power Supply Schematic
REASON FOR CHANGE:	To reduce turn-off thump on TFM-45 only.	
PROCEDURE:	Change R69. Add R70.	

ECO#:1451	DATE: 05/08/90	REV.D Power Supply Board Assembly REV.D Power Supply Schematic REV.B TFM-45 Meter Drive Board Assembly REV.B TFM-45 Meter Drive Schematic
REASON FOR CHANGE:	To correct errors on schematic drawing. To stabilize +31Vdc supply (TFM-45 version). To add thermal switch to correct assembly level. To stabilize meter lamp brightness.	
PROCEDURE:	Switch R34 and R35 reference designators. Move D28 on schematic diagram. Change R67 and add JP23 (TFM-45 version). On Regulator Board: Add thermal switch. On TFM-45 Meter Drive Board: Add a 1kΩ resistor across R453.	

ECO#:1491	DATE:06/18/90	REV.E Power Supply Board Assembly REV.E Power Supply Schematic
REASON FOR CHANGE:	To change C-26. To correct reference designation on JP23. To correct error on schematic drawing.	
PROCEDURE:	Change wire length on C-26 air capacitor to 2". Change JP23 reference designation (see ECO#1451) to JP25. Correct +13V connection at J6 on schematic drawing.	

ECO#:1517	DATE:07/26/90	REV.D Amp Parts List - Effective S/N 1200 (TFM-42) S/N 2760 (TFM-45) REV.B Amplifier Schematic REV.E Regulator Board Assembly REV.J Final Assembly TFM-42 and TFM-45
REASON FOR CHANGE:	To stabilize damping pot drift. To improve manufacturing efficiency. To reduce audible transformer noise. To show CLA approval.	
PROCEDURE:	Change RP2 and add R9. Add quick disconnects to triac. Add fiberglass insulation to top cover. Add CLA label.	

ECO#:1554 DATE:08/21/90 REV.F Power Supply Board Assembly
REV.F Power Supply Schematic
REV.M Final Assembly TFM-42 and TFM-45
REV.E Wiring Diagram TFM-42 and TFM-45

REASON FOR CHANGE: To reduce buzz in outputs.
PROCEDURE: Remove D18-D21. Add two wires and bridge rectifier. Delete C26.

ECO#:1575 DATE:09/12/90 REV.N Final Assembly TFM-42 and TFM-45
REV.F Wiring Diagram TFM-42 and TFM-45
REV.C Amp Board Assembly
REV.B Amp PCB

REASON FOR CHANGE: Transformer damping no longer needed. To show quick disconnect cable
assembly on wiring diagram. Add RP2 and R9 to artwork (see ECO#1517).
PROCEDURE: Remove fiberglass insulation from top cover (see ECO#1517). Show quick
disconnect cable assembly on wiring diagram (see ECO#1517).

ECO#1619: DATE:01/05/91 REV.G Regulator Board Assembly
REV.P Final Assembly TFM-42 and TFM-45

REASON FOR CHANGE: Use different thermal switch.
PROCEDURE: Change thermal switch and mounting bracket.

ECO#:1643 DATE:01/16/91 REV.T Final Assembly TFM-42 and TFM-45
REV.K Power Supply Board Assembly
REV.G Power Supply Schematic
REV.H Wiring Diagram TFM-42 and TFM-45

REASON FOR CHANGE: To reduce noise in outputs.
PROCEDURE: Add transformer shield, mounting bracket and nylon edging. Change R60 and
R64 on power supply board.

Appendix D

VOLTAGE CONVERSION FOR M-4.0t, TFM-4.0, TFM-42/45

Bill of Materials

Qty	Part Number	Description
1	315-13004-00	Fuse MDA 6-1/4A
1	315-13002-00	Fuse MDA 12A
1	530-10037-00	Label MDA 6-1/4A
1	530-10094-00	Label 230VAC 50Hz
1	530-20044-00	Label, Voltage Conversion (M-4.0t/TFM-4.0)
1	530-10136-00	Label, Voltage Conversion (TFM-42/45)
1	530-10013-00	Label, Military Conversion

Directions for Change (115V to 230V)

1. Set the switch on the power supply regulator board to the 230V position.
2. Replace the MDA 12A fuse with an MDA 6-1/4A fuse (P/N 530-10037-00).
3. Attach the MDA 6-1/4A fuse label (530-10037-00) over the MDA 12A printing near the fuseholder.
4. Attach the 230VAC 50Hz label over the 120VAC 60Hz printing near the line cord.
5. Attach the Voltage Conversion label (P/N 530-20044-00 for M-4.0t/TFM-4.0; P/N 530-10136-00 for TFM-42/45) to the inside of the top cover. Do not block ventilation slots.
6. Attach the Military Conversion label (P/N 530-10013-00) to the rear of the chassis.

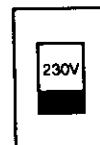

Directions for Change (220V to 115V)

1. Set the switch on the power supply regulator board to the 115V position.
2. Replace the MDA 6-1/4A fuse with an MDA 12A fuse (P/N 315-13002-00).
3. Remove the MDA 6-1/4A fuse label near the fuseholder.
4. Remove the 230VAC 50Hz label near the line cord.

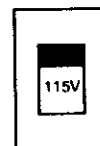

Appendix E

SERVICE BULLETINS

Please insert Carver Service Bulletins pertaining to the M-4.0t, TFM-4.0, TFM-42 or TFM-45 here to ensure proper repair in the future.

CARVER CORPORATION SERVICE BULLETIN

Service Bulletin # M-4.0t-1

Model M-4.0t

Serial # up to 1366

Reason: Too much "BUZZ" (60Hz) with input jacks unterminated.

Procedure: Route Transformer Secondary wire bundle behind terminal strip. Use a snake lug on back side of terminal strip to hold wires. On inside front transformer mounting bolt remove nut and scrape metal clean. Add a #6 solder lug and retighten mounting nut. Add 7 inches of Blk #22 wire from the solder lug to main power supply board ground and route with the secondary wires, with wraps at every 2 inches. Remove R61 (2.2K ohm) and R60 (470K ohm) on Power Supply PCB. Add Qty (2) 100K 1/4W and Qty (1) 680 ohm as shown. from ECO 900

Delete: R60 251-00078-03 2.2K 1/4W
R61 251-00134-00 470K 1/4W

Add: Qty. 2 251-00118-03 100K 1/4W
Qty. 1 251-00066-03 680 ohm
Qty. 1 111-20051-00 #6 lug
Qty 1 401-10502-00 wire #22 ga

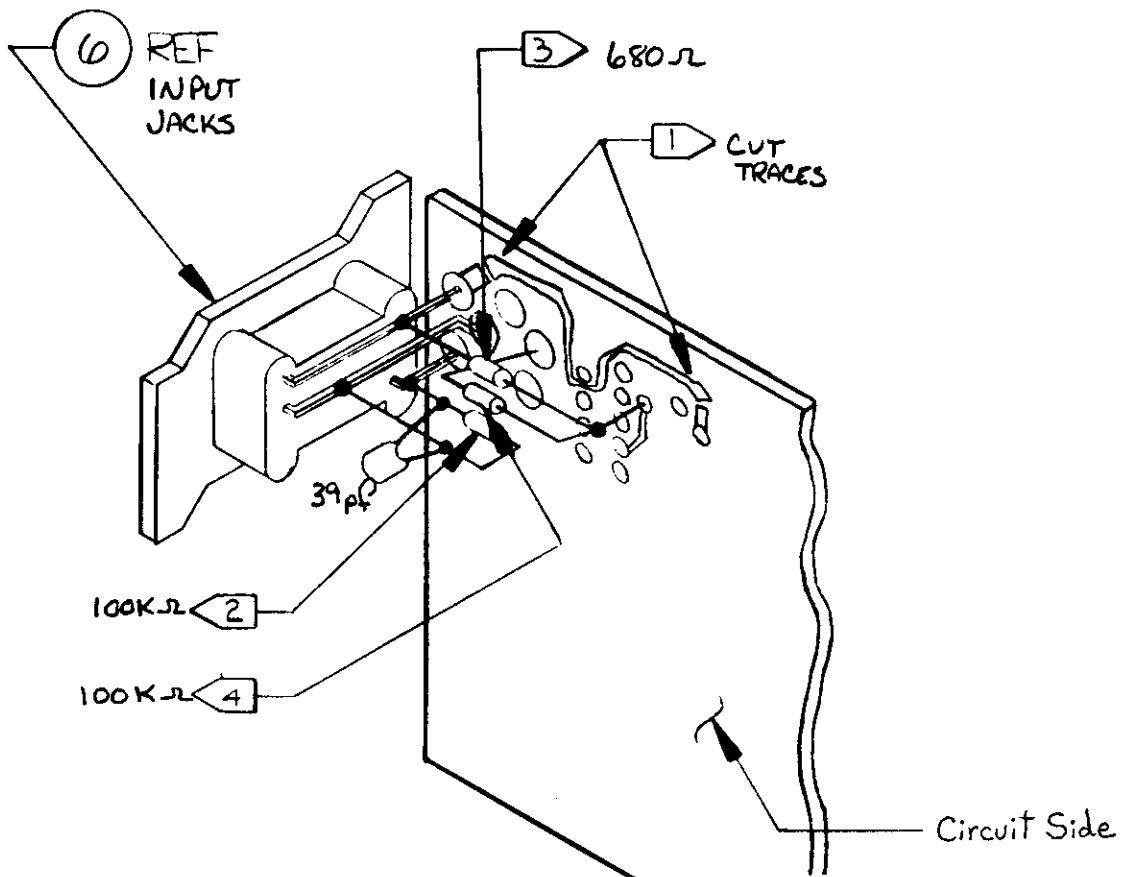

SERVICE APPROVAL _____
ENGINEERING APPROVAL _____

1/16/89

DATE

CARVER CORPORATION
SERVICE BULLETIN

Service Bulletin # M-4.0t-1A

Model M-4.0t

Serial # Below S/N 0821

Reason: Triac misfiring.

Procedure: Add a 20K ohm 1W resistor across the AC terminals of BR1 bridge.
This AC part of the bridge has the yellow wires from the secondary
of the transformer.

Delete:

Add: Qty-1 255-10137-03
(met. oxide 20K 1W)

SERVICE APPROVAL

ENGINEERING APPROVAL

Wayne Smith 5/26/89
W. H. ... 5-27-89

DATE

CARVER CORPORATION
SERVICE BULLETIN

Service Bulletin # M-4.0t-2

Model M-4.0t

Serial # up to 3055

Reason: If the customer complains about an unacceptable delayed turn off thump with complex speaker loads follow this procedure.

Procedure: Change value of R-54 in the power supply from a 15k ohm 1 watt to a 9.1k ohm 1 watt.

Delete: Qty-1 255-10133-03 (15k ohm
1 watt)

Add: Qty-1 255-10120-00 (9.1k ohm 1
watt)

SERVICE APPROVAL

ENGINEERING APPROVAL

Wayne Bennett 5/2/89
W. Bennett 6-20-89

DATE

**CARVER CORPORATION
SERVICE BULLETIN**

Service Bulletin # TFM-45-1

Model TFM-45

Serial # Below S/N 2161

Reason: If the customer complains of the meters dimming to the music.

Procedure: 1) On the power supply board install a jumper wire across R67.
2) On the meter board install a 1K ohm 1/4W resistor across R453 on the foil side of the board. (SEE FIGURE 1)
3) On the power supply board install a 300 ohm 2W resistor on the foil side of the board. Be sure to space the resistor for proper cooling. (SEE PAGE 2)

Delete: Qty-1 255-20072-00 130 ohm
2W This resistor is by-
passed by the jumper wire.

Add: Qty-1 255-20083-00 300 ohm 2W
Qty-1 251-00070-00 1K ohm 1/4W
Qty-1 401-30013-00 jumper .8"

SERVICE APPROVAL _____
ENGINEERING APPROVAL _____

R. Cooper
W. Richardson

1-3-90

DATE

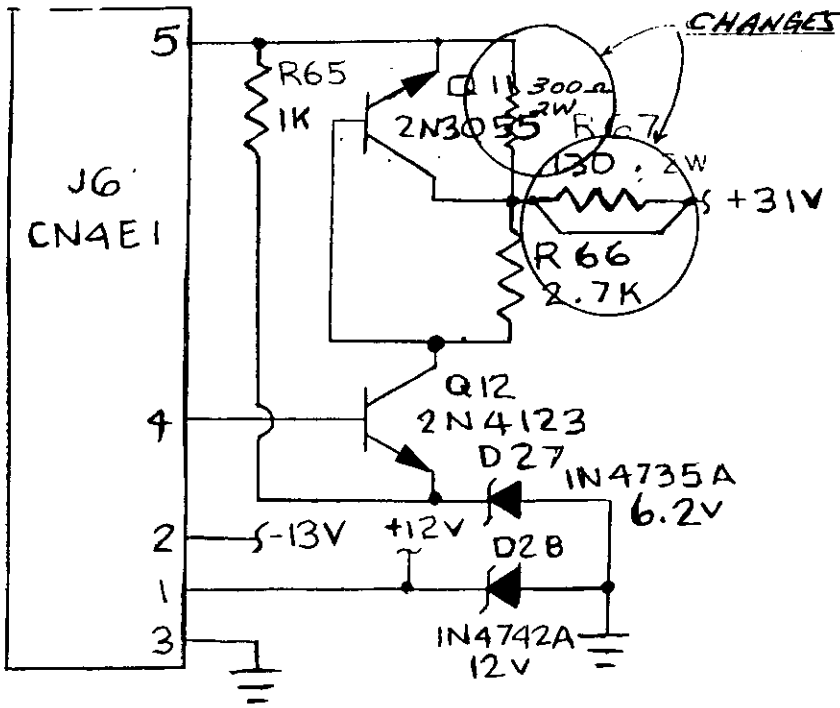

TFM 45 VERSION ONLY

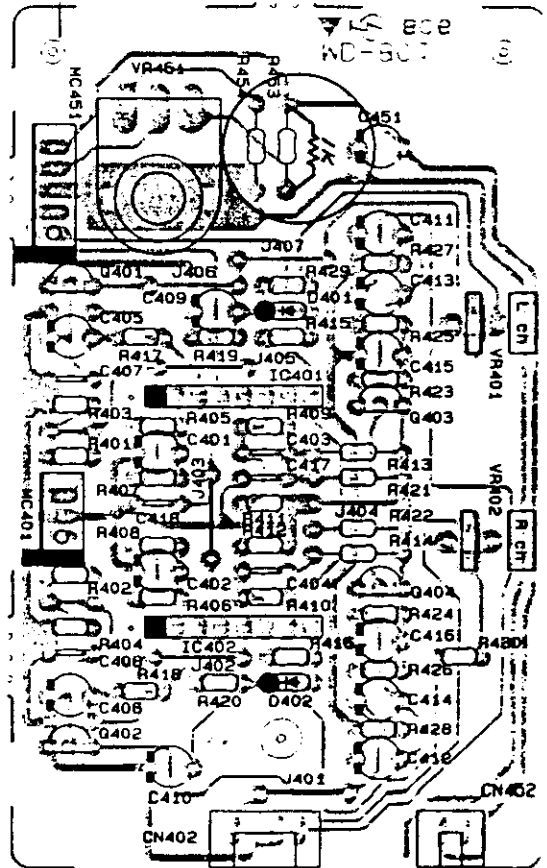
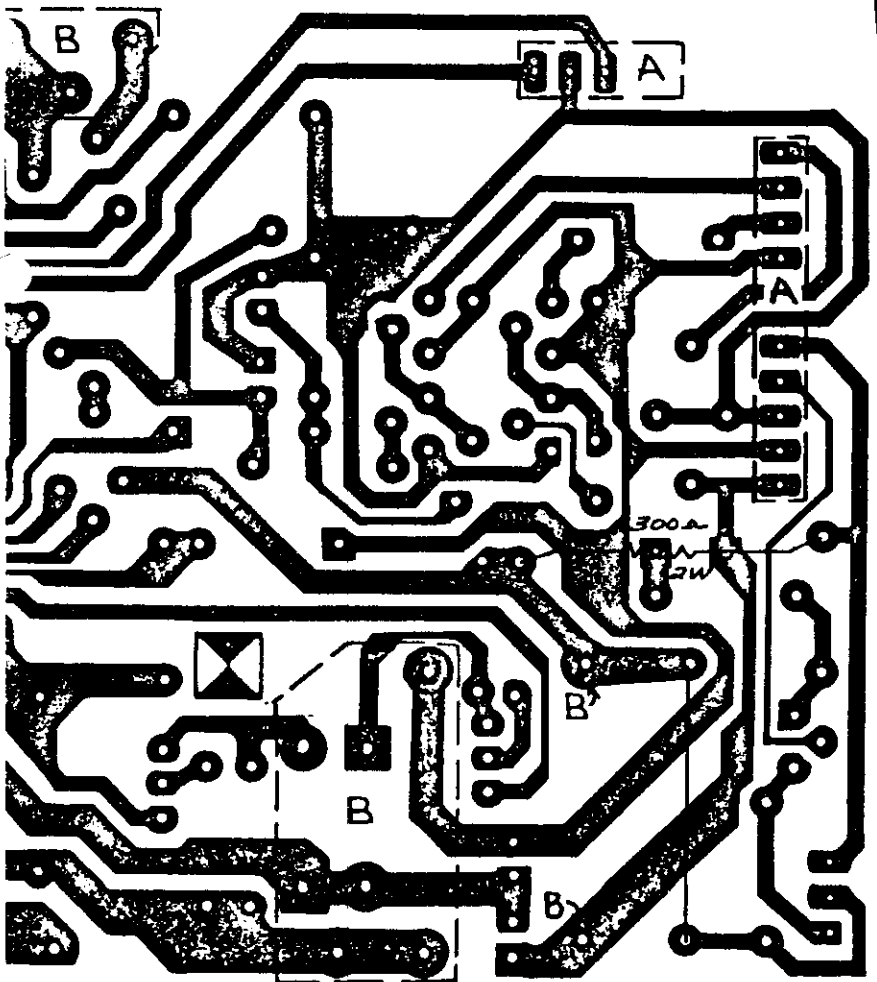
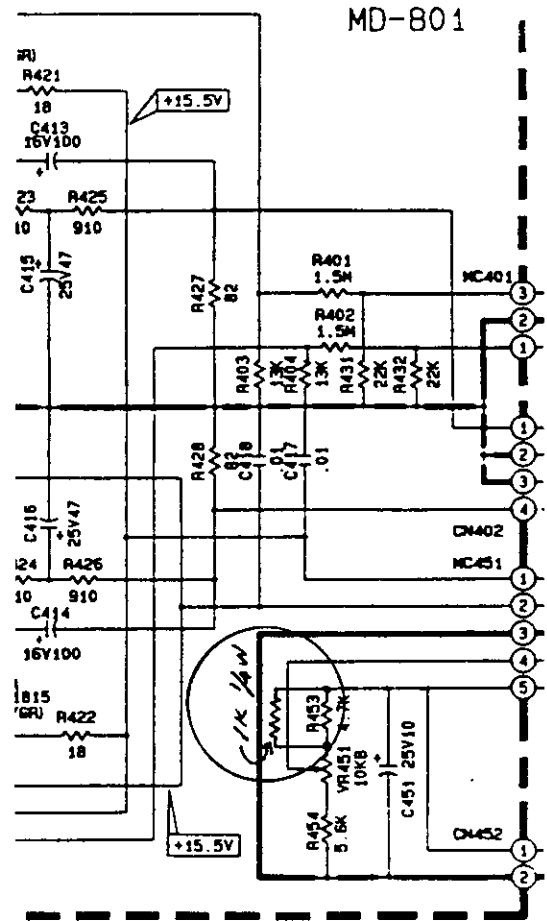

**CARVER CORPORATION
SERVICE BULLETIN**

Service Bulletin # TFM-45-2A

Model TFM-45

Serial # Below S/N 1659

Reason: If the customer complains of turn off squeals.

Procedure: At location R69 remove an 820 ohm 2W resistor. Replace the resistor with two 680 ohm 2W resistors in parallel.
*SEE FIGURE 1

Delete: Qty-1 253-20100-00 820 ohm 2W

Add: Qty-2 255-20095-00 680 ohm 2W

FIGURE 1

TO:

FROM:

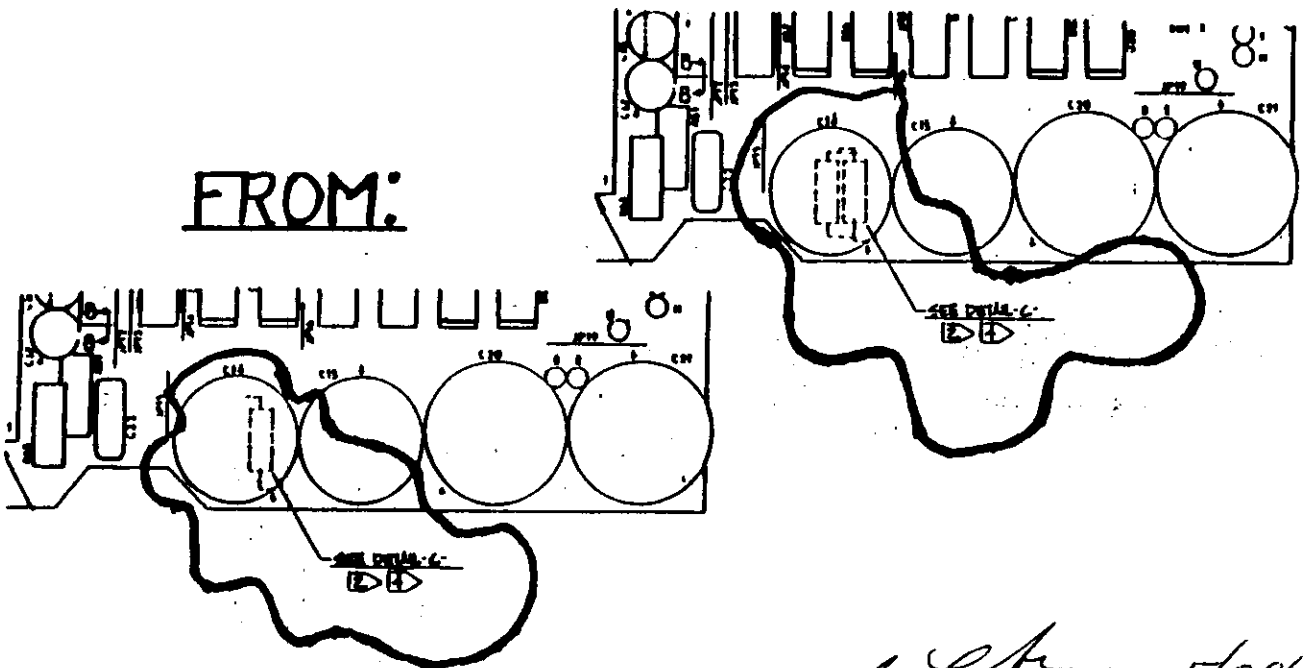

SERVICE APPROVAL
ENGINEERING APPROVAL

B. C. P. 5/29/90
W. Richardson 5/29/90

DATE

CARVER CORPORATION SERVICE BULLETIN

Service Bulletin # TFM-45-3	Model: TFM-45, TFM-42	Serial Nos. TFM-45 Below 90910400001 TFM-42 Below 90910900001
REASON: Excessive buzz from 67Vdc rails.	TFM-4.0, M-4.0t	TFM-4.0, M-4.0t All
		Date: 8/21/90

DELETE	ADD
Qty 2 Wire 22AWG (Air capacitor C26) 401-10629-00	Qty 1 Wire 18AWG Brown 5" 401-10129-01
Qty 4 Diode 6A, 200V (D18, D19, D20, D21) 320-20010-03	Qty 1 Wire 18AWG White 5" 401-10158-00
	Qty 1 Machine Screw #4-40x9/16" 151-20004-00
	Qty 1 Kepnut #4-40 152-10001-00
	Qty 1 Bridge Rectifier 6A, 200V 319-00030-00

PROCEDURE

1. Remove D18, D19, D20, D21 from power supply board.
2. Install the Bridge Rectifier (319-00030-00) as shown in Figure 1 using a 4-40x9/16" machine screw and a 4-40 kepnut.
3. Remove orange secondary wires from location 'C' and 'G' on the power supply board and route them to the AC pins of the bridge rectifier. Route the brown 18AWG wire from the positive pin of the rectifier to the hole left of the cathode of D20. Route the white 18AWG wire from the negative pin of the rectifier to the hole left of the anode of D19.
4. Remove C26 (2 wires forming air capacitor - see Figure 2).

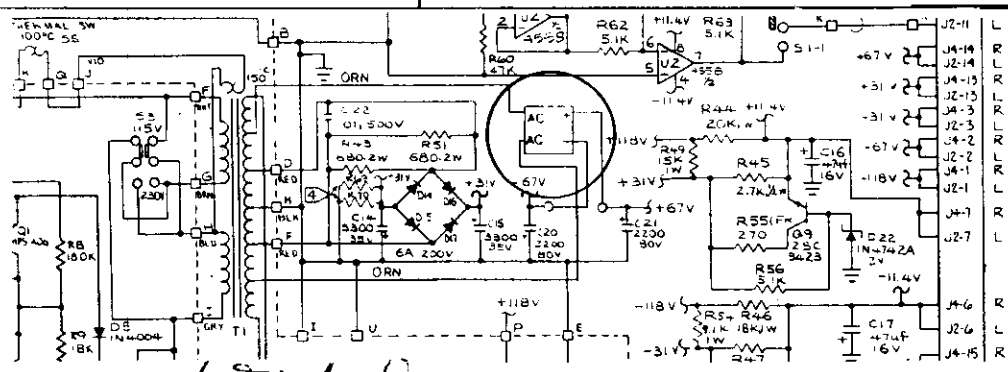
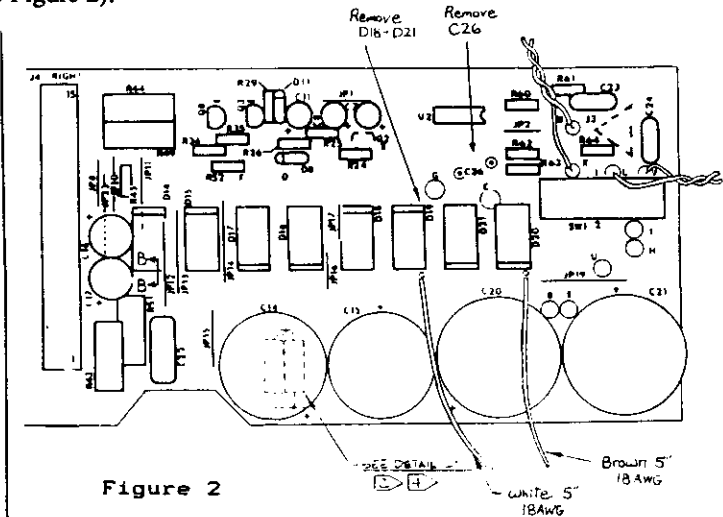
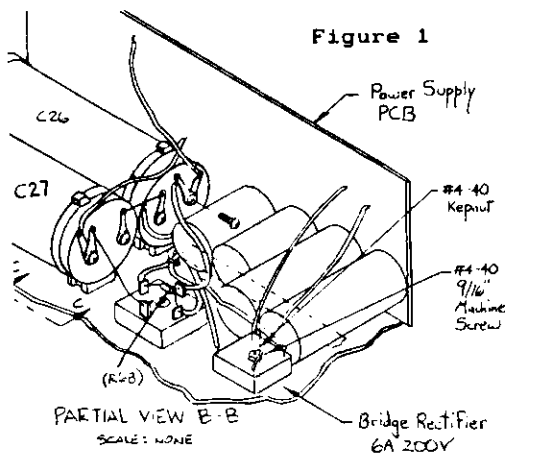

Engineering Approval *W. J. Johnson* Date 3-21-91
 Service Approval *S. J. Johnson* Date 3-21-91

CARVER CORPORATION

SERVICE BULLETIN

Below TFM-42: 01200

Service Bulletin # TFM-45-4 | Model: TFM-45/42 | Serial nos. TFM-45: 02760

REASON: To eliminate damping pot drift. | Date: 7/26/90

DELETE	ADD
Qty 2 259-20010-00 2k Pot (RP2)	Qty 2 259-30001-00 500 ohm Pot (RP2)
	Qty 2 251-00067-00 750 ohm 1/4W resistor (R9)

PROCEDURE

- On both amp boards, replace RP2 with 500 ohm pot.
- On foil side of each board, cut trace between RP2 and U2 pin 3. (See Figure 1A).
- Solder R9, 750 ohm 1/4W resistor, between RP2 and U2 pin 3. (See Figure 1B).

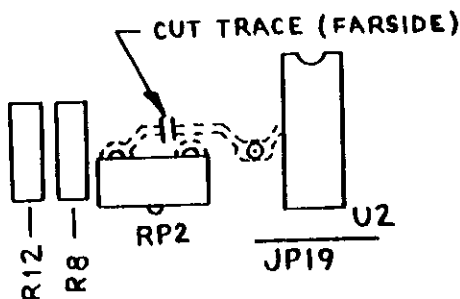

Figure 1A

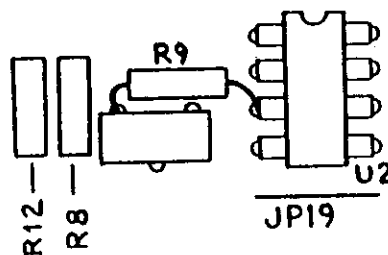
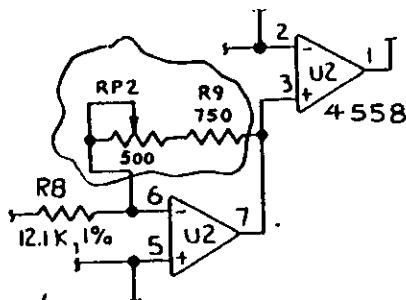

Figure 1B



Engineering approval *Van Richardson* 1-8-91

Service approval *B. [Signature]*

CARVER CORPORATION

SERVICE BULLETIN

Below TFM-42 91110900001

Service Bulletin # TFM-45-5

Model: TFM-45/TFM-42

Serial nos. TFM-45 91110400001

REASON:

Date: 1/28/91

To reduce noise in outputs,

DELETE

Qty 2 100K ohm 1/4W resistor (R60, R64)
251-00118-00

ADD

Qty 2 47k ohm 1/4W resistor (R60, R64)
251-00110-00
Qty 2 Bracket
101-22006-01
Qty 1 Transformer Shield
511-00005-00
Qty 2 #6-32 X 3/8" Machine Screw
151-20052-00
Qty 2 #6 Kepnut
152-10002-00
Qty 1 Nylon Edging 3.5"
104-00001-00

PROCEDURE

To install transformer shield:

1. Use the #6-32 X 3/8" machine screws (151-20052-00) and #6 kepnuts (152-10002-00) to attach the two brackets (101-22006-01) to the transformer shield (511-00005-00).
NOTE: Screws go through shield first and then through hole in short end of bracket. The long end of bracket should be nearest the bottom edge of the shield.
2. Install the nylon edging along the bottom edge of the shield.
3. Remove upper nut from the two transformer mounts on the right hand side of the transformer (side nearest speaker output binding posts). Install transformer shield assembly so that the holes in the long end of the two brackets are positioned over the transformer mounting bolts and the shield is positioned between the transformer and the speaker output binding posts (see Figure 1).
4. Re-install the two nuts onto the transformer mounts, over the transformer shield brackets.

NOTE: To further reduce noise:

- a) route transformer secondary wires beneath the transformer shield and under R99L and R99R.
- b) route twisted pairs on power supply board as close to the top of the board as possible.
- c) route wiring from filter caps as close to the power supply board as possible.

To change input impedance from 110k to 47k:

1. Replace R60 and R64 on the power supply board with 47k ohm 1/4W resistors (251-00110-00). See Figure 2.

Engineering approval

W. Richardson 1-28-91

Service approval

B. Coffman

CARVER CORPORATION SERVICE BULLETIN

Service Bulletin # TFM-45-5 Model: TFM-45/TFM-42 Serial nos. See page 1

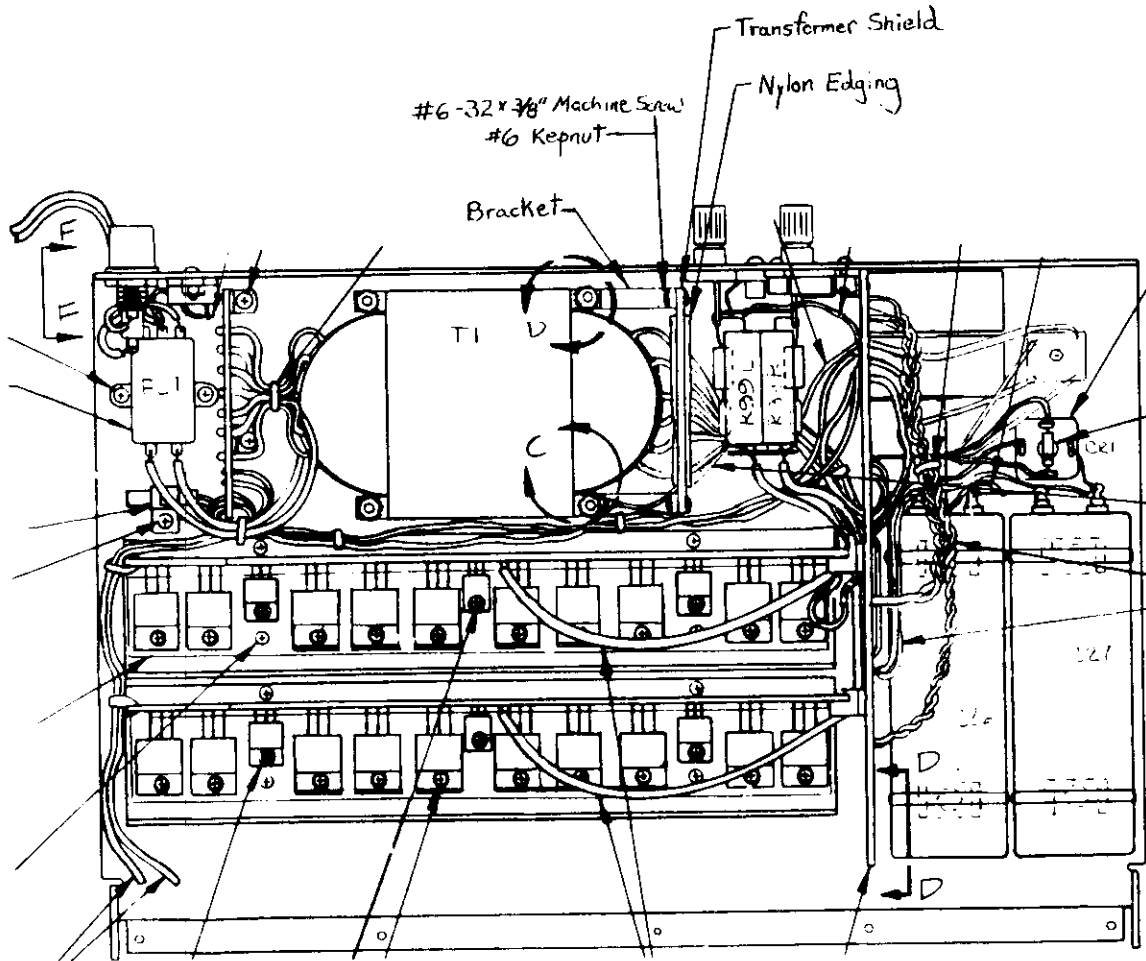

Figure 1

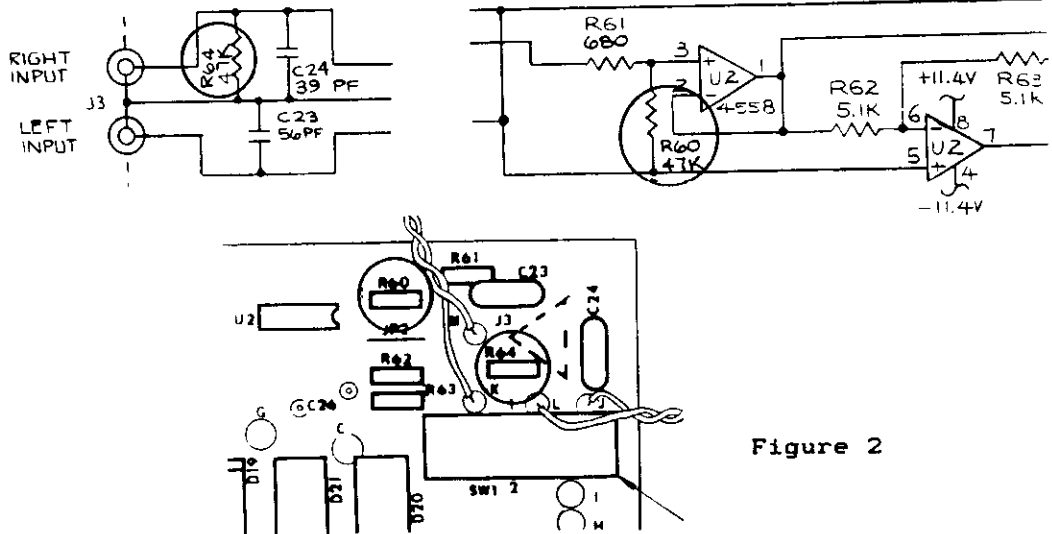

Figure 2

TFM-45/42 Power Supply PCB

CARVER CORPORATION SERVICE BULLETIN

Service Bulletin # TFM-45-6	Model: TFM-45	Serial Nos. As Needed
REASON: If customer complains of turn-off/turn-on thump.		Date: 4/12/91
DELETE	ADD	

PROCEDURE

Turn-off thump in the TFM-45 is caused by non-symmetrical discharging of the low rail supply voltage (+/-31Vdc). Because the meter lights cause an added drain on the +31Vdc supply, R69 and R70 load the -31Vdc supply to compensate. However, this may not entirely eliminate turn-off thump in every case, and further action may be necessary.

Before proceeding, in order to minimize noise/buzz/hum:

1. Verify that Service Bulletin TFM-45-3 has been performed. This removes D18-D21 and C26 from the power supply board, and adds an off-board bridge rectifier.
2. Verify that Service Bulletin TFM-45-5 has been performed. This adds a shield between the power transformer and the power supply board, and changes the input impedance from 110kΩ to 47kΩ.
3. Replace the 9" red/white and black twisted pair on the power supply board (connecting 'J,O' and 'L,N') with a 7" 3-conductor shielded twisted pair (i.e. Manhattan Electric M-3202 or equivalent). Tie the shield to 'L', which is signal ground near the input jack.

TEST FOR TURN-OFF/TURN-ON THUMP

1. Drive both channels with a 2kHz sine wave into 8 ohm loads. Monitor outputs with an analog AC Voltmeter and adjust the level for .775 Vrms output. Turn the meter dimmer pot fully clockwise (to the brightest position).
2. Turn the power switch off and verify turn-off thump is less than 1 Vrms on the meter. Monitor for about ten seconds.
3. Turn unit back on and verify less than 1 Vrms on the meter.

CURES

If no thump is visible on the meter using resistive loads, find out if the customer has AC coupled speakers. If so try shorting C5 (470μF/16V) on both amplifier boards. This can be done by shorting across the leads of C5 with buss wire, or by removing the capacitors and installing jumper wires in their place. This is not recommended for normal reactive speaker loads, because this modification may cause an increase in the dc offset at the outputs.

Service Approval

[Signature]

Engineering Approval

[Signature]

4-15-91

CARVER CORPORATION SERVICE BULLETIN

Service Bulletin # TFM-45-6

Model: TFM-45

Serial Nos. As Needed

If turn-off/turn-on thump exceeds 1 Vrms, try one or more of the following possible cures:

- A) Be sure the meter dimmer pot is fully clockwise. The setting of the meter dimmer pot will affect the loading on the +31Vdc supply.
- B) Verify that the 4558 IC's (U2) in the amplifier boards are either:

XR4558 (manufactured by Exar)
RC4558 (manufactured by Raytheon)

It has been found that other brands of 4558's can cause turn-off thumps and squeals in this particular application (not to mention more wide-band noise).

- C) Try swapping the 31Vdc filter capacitors (i.e., use the positive filter capacitor in the negative supply, and vice versa). Differences in capacitances may equalize the discharge rate of the supply at turn-off.
- D) If that doesn't help, try swapping the 67Vdc filter capacitors.
- E) Try adding a 3.6K 2W resistor from the +31Vdc supply to ground.
- F) Try adding four 6.8K 2W resistors in parallel from the -67Vdc supply to ground.

CARVER CORPORATION SERVICE BULLETIN

Service Bulletin # TFM-45-7	Model: TFM-42/45	Serial Nos. TFM-42 Below 91710900001 TFM-45 Below 91710400001
-----------------------------	------------------	--

REASON: To secure connection between amp boards and power supply board.	Date: 06/18/91
---	----------------

DELETE	ADD Qty 2 Tyrap 10" 159-50005-00 Qty 2 Wire, 18AWG TEW, Black 3" 401-10102-00
--------	---

PROCEDURE

1. Solder one 3" 18 AWG black wire between J2 pin 12 on the power supply board and J2 pin 12 on the left amp board. Solder another 3" 18 AWG black wire between J4 pin 12 on the power supply board and J2 pin 12 on the right amp board (see Figure 1).
 Note: This step does not need to be performed if the connectors (J2 and J4) are gold plated.
2. Tyrap power supply board and amp boards together as shown in Figure 2.

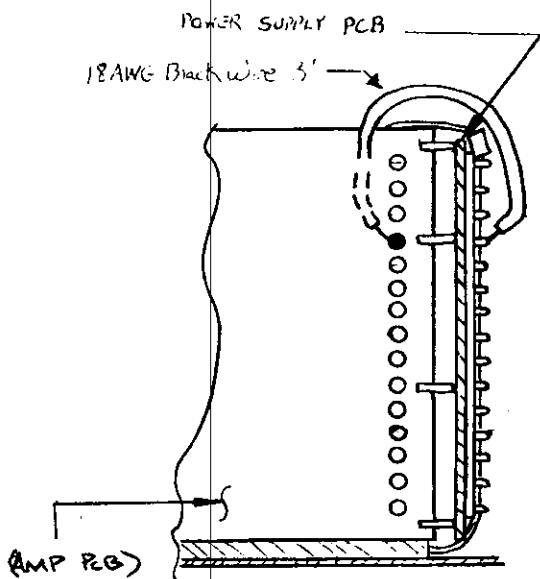

Figure 1

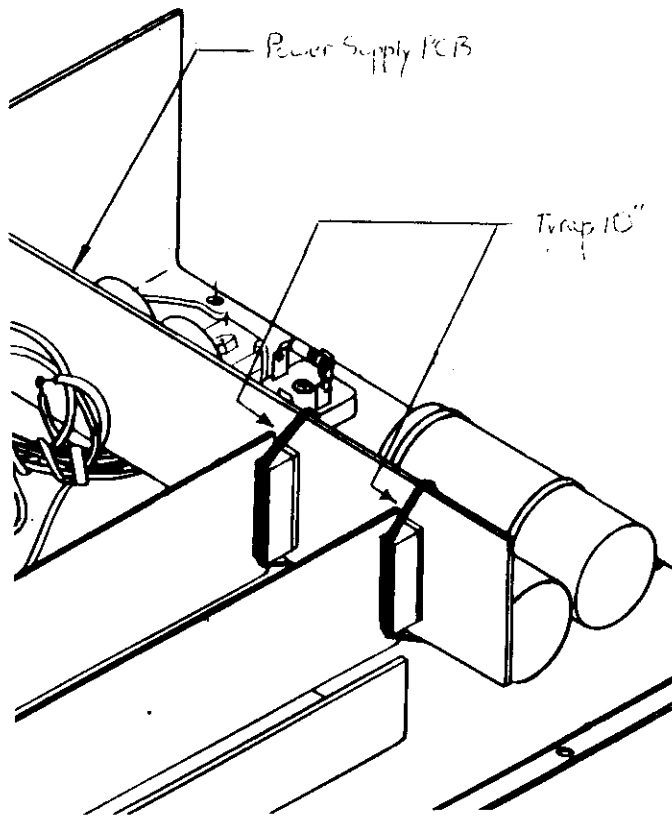

Figure 2

Service Approval <i>Scott Coffman</i> 6/18/91	Engineering Approval <i>David Johnson</i> 6/18/91
--	--